

HDBaseT Extender

HDC-TH200

<User's Guide>

Ver.1.1.0

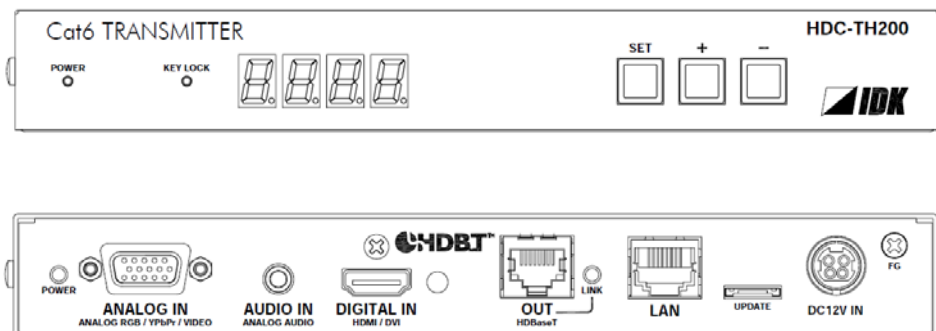

- Thank you for choosing our HDBset Extender.
- To ensure the best performance of this product, please read this User's Guide fully and carefully before using it and keep this manual beside the product.

Trademarks

- Blu-ray Disc and Blu-ray are trademarks of Blu-ray Disc Association.
- The terms HDMI and HDMI High-Definition Multimedia Interface, and the HDMI Logo are trademarks or registered trademarks of HDMI Licensing, LLC in the United States and other countries.
- PJLink is a trademark in Japan, the United States, and other countries/regions.
- HDBaseT™ and the HDBaseT Alliance Logo are trademarks of the HDBaseT Alliance.
- Microsoft, Windows, Internet Explorer are either registered trademarks or trademarks of the Microsoft Corporation in the United States and other countries.
- ETHERNET is registered trademark of Fuji Xerox Corporation.
- Mozilla, Firefox and its logo are trademarks or registered trademarks of the Mozilla Foundation in the United States and other countries.
- Google Chrome is trademark or registered trademark of Google Inc.
- Javascript® is trademark or registered trademark of the Oracle Corporation and its related companies in the United States and other countries.
- Oracle and Java are registered trademarks of the Oracle Corporation and its related companies in the United States and other countries.
- All other company and product names mentioned in this manual are either registered trademarks or trademarks of their respective owners. In this manual, the “®” or “™” marks may not be specified.

Before reading this manual

- All rights reserved.
- This Users guide is subject to change without notice. You can download the latest version from IDK's website at: <http://www.idk.co.jp/en/index.html>

FCC STATEMENT

This equipment has been tested and found to comply with the limits for a Class A digital device, pursuant to part 15 of the FCC Rules. These limits are designed to provide reasonable protection against harmful interference when the equipment is operated in a commercial environment. This equipment generates, uses, and can radiate radio frequency energy and, if not installed and used in accordance with the instruction manual, may cause harmful interference to radio communications. Operation of this equipment in a residential area is likely to cause harmful interference, in which case the user will be required to correct the interference at their own expense.

CE MARKING

This equipment complies with the essential requirements of the relevant European health, safety and environmental protection legislation.

WEEE MARKING





Waste Electrical and Electronic Equipment (WEEE), Directive 2002/96/EC
(This directive is only valid in the EU.)







This equipment complies with the WEEE Directive (2002/96/EC) marking requirement.







The left marking indicates that you must not discard this electrical/electronic equipment in domestic household waste.





Safety instructions

Read and understand all safety and operating instructions before using this product. Follow all instructions and cautions as detailed in this document.

Enforcement Symbol	Description
 Warning	Indicates the presence of a hazard that may result in death or serious personal injury if the warning is ignored or the equipment is handled incorrectly.
 Caution	Indicates the presence of a hazard that may cause minor personal injury or property damage if the caution is ignored or the equipment is handled incorrectly.

Symbol	Description	Example
 Caution	This symbol is indicated to alert the user. (Warning and caution)	 Electrical Hazard
 Prohibition	This symbol is intended to prohibit the user from actions.	 Do not disassemble
 Instruction	This symbol is intended to instruct the user.	 Unplug

 Warning	
 Prohibition	Do not place the product in any unstable place. Install the product to a horizontal and stable place. Otherwise, it may fall/turn over and lead to injury.
	Do not place the product in any environment with vibration. Otherwise, it may move/fall and lead to injury.
	Keep out any foreign objects. In order to avoid fire or electric shock, do not allow foreign objects, such as metal and paper, to enter the product from the vent holes.
	For power cable/ plug: <ul style="list-style-type: none"> • Do not scratch, heat, or modify, including extending them. • Do not pull, put heavy stuff on them, or pinch them. • Do not bend, twist, or tie them together forcefully. If they are used in those states continuously, it may cause fire or electric shock. If power cables/plugs become damaged, contact IDK.
 Do not disassemble	Do not repair, modify or disassemble. Since the product includes high-voltage part, those actions may cause fire or electric shock. For internal inspections or repairs, contact IDK.
 Do not touch	In the event of lighting or thunder, do not touch the main unit and cables such as power cable and LAN cable. Contact may cause electric shock
 Instruction	For installation: The product is intended to be installed by skilled technicians. For installation, please contact a system integrator or IDK. Otherwise, it may cause fire, electric shock, injury, or property damage.
	Set the power plug in a convenient place to unplug easily. You can easily unplug in case of any extraordinary failure or abnormal situation, and it also helps for unplugging when you do not use it for a long period.
	Plug the power plug into appropriate outlet completely. If the plug is plugged incompletely, it may overheat which causes electrical shock or fire. Do not use damaged plug or loosened outlet.
	Clean the power plug regularly. If the plug is covered in dust, it may cause fire due to reduced insulating power.
 Unplug	Unplug immediately if the product smokes, makes unusual noise, or smells. If you continue to use the product under those situations, it may cause electric shock or fire. After confirming that the product stops smoking, contact IDK.
	Unplug immediately if you drop the product or if the cabinet is damaged. If you continue to use the product under those situations, it may cause electrical shock or fire. For maintenance and repair, contact IDK.
	Unplug immediately if water or other objects are directed inside. If you continue to use it under those situations, it may cause electrical shock or fire. For maintenance and repair, contact IDK.
For connection	
 Instruction	Differences in ground potential among the product and peripheral devices may cause electric shock or damage of the devices. When using cables to connect devices, including connection of long-distance transmission, unplug the power cables of all related devices. After connecting signal/control cables of each device, plug in the power cables of each device.

 Caution	
 Prohibition	<p>Do not place the product in any place where it will be subjected to high temperatures. If the product is subjected to direct sunlight or high temperatures, it may cause fire.</p>
	<p>Do not place the product in humid, oil smoke, or dusty place. If the product is placed near humidifiers or dusty area, it may cause fire or electric shock.</p>
	<p>Do not block the vent holes. If ventilation slots are blocked, it may cause fire or failure due to internal heat.</p>
	<p>Do not put heavy items on the product. It may fall/turn over and lead to injury.</p>
	<p>Do not exceed ratings of outlet and wiring devices. If several plugs are put in an outlet, it may cause fire and electric shock.</p>
	<p>Use only the provided AC adapter and power cable. If non-compliant adapter or power cables is used, it may cause fire or electrical shock. Use the provided AC power connection cable. If you want to use your product in other countries that use different AC power cables, contact IDK.</p>
 No wet hands	<p>Do not plug or unplug with wet hands. It may cause electrical shock.</p>
 Instruction	<p>Use and store the product within the specified temperature/humidity range. If the product is used outside the range continuously, it may cause fire or electric shock.</p>
	<p>Turn off devices when they are connected to another device. It may cause fire or electric shock.</p>
 Unplug	<p>Unplug the power plug if you do not use the product for a long period. In case of defect, it may cause fire.</p>
	<p>Unplug the power plug before cleaning. It may cause electric shock.</p>

For installation

For rack mount devices:

 Instruction	<p>Mount the product to the rack meeting EIA standards, and maintain spaces above and below for air cooling. For your safety, attach an L-shape bracket in addition to the mount bracket kit for the front panel to balance the weight.</p>
---	---

For devices with rubber feet:

 Instruction	<p>Never insert only the screws into the holes after removing the rubber feet. It may lead to damage when the screws contact electrical circuit or parts inside of the product. To put the rubber feet back on, use only provided rubber feet and screws.</p>
---	---

Altitude:



Instruction

Do not place the product at elevations of 2,000 meters (6562 feet) or higher above sea level. Failure to do so may shorten the life of the internal parts and result in malfunctions.

Table of Contents

1	Included items	10
2	Product outline	11
3	Features	12
4	Panels	13
4.1	Front panel	13
4.2	Rear Panel	14
5	Example connection	15
6	Precautions	16
6.1	Installing rubber feet	16
6.2	Installation	16
6.3	Cabling	17
6.3.1	Cables	17
6.3.2	Twisted pair cable	18
6.3.3	DIN plug AC adapter	19
6.3.4	Analog video input connector	21
6.3.5	Connection between HDC-TH200 and MSD-402	21
7	Basic operation	22
7.1	Menu operations	22
7.2	Locking menu operation keys	23
7.3	Initialization	23
8	Menus	24
8.1	Menu list	25
8.2	Input switching setting	28
8.2.1	[F05] Priority of input channel automatic switching	28
8.2.2	[F06] Audio	29
8.2.3	[F00] Manual input channel switching	30
8.3	Input settings	31
8.3.1	[F16] No-signal input monitoring	31
8.3.2	[F17] Digital input equalizer	31
8.3.3	[F07] Analog input signal type	32
8.3.4	[F64] Color bit for analog video input	32
8.4	EDID	33
8.4.1	[F01] Copying EDID	33
8.4.2	[F10 to F11] Setting EDID resolution	34
8.4.3	[F76 to F77] Setting EDID WXGA	35
8.4.4	[F20] Setting Deep Color	36
8.4.5	[F22] Setting PCM Audio	36
8.4.6	[F24] Setting AC-3 Dolby Digital Audio	37
8.4.7	[F26] Setting AAC Audio	37
8.4.8	[F28] Setting Dolby Digital Plus Audio	38
8.4.9	[F30] Setting DTS Audio	38
8.4.10	[F32] Setting DTS-HD Audio	39
8.4.11	[F34] Setting Dolby TrueHD Audio	39
8.4.12	[F36] Setting Audio channel	40
8.4.13	[F38] Copying CEC physical address copy of EDID	41
8.5	Setting analog video timing	42
8.5.1	[F08] Automatic measurement	42

8.5.2	[F40] Analog video automatic adjustment	44
8.5.3	[F42] Setting the total number of horizontal dots.....	46
8.5.4	[F43] Starting position of horizontal dots	47
8.5.5	[F44] Horizontal Active area.....	47
8.5.6	[F45] Horizontal display start position.....	48
8.5.7	[F46] Display period of horizontal dots	48
8.5.8	[F47] Horizontal sync signal width.....	49
8.5.9	[F48] Starting position of vertical lines.....	50
8.5.10	[F49] Vertical active area.....	50
8.5.11	[F50] Vertical display strat positoin	51
8.5.12	[F51] Display period of vertical lines	51
8.5.13	[F52] Vertical sync signal width.....	52
8.5.14	[F53] Tracking.....	52
8.6	Output settings.....	53
8.6.1	[F65] Setting audio output.....	53
8.6.2	[F70] Setting Deep Color output	53
8.7	Other settings.....	54
8.7.1	[F90] Displaying firmware version.....	54
8.7.2	[F99] Setting maintenance/status display menu.....	54
8.8	Checking operation (Maintenance menu).....	55
8.8.1	[C01] Setting sink device EDID check.....	55
8.8.2	[C06] Setting HDCP input.....	56
8.8.3	[C10] Setting how long hot plug is ignored.....	57
8.8.4	[C30] Masking time after automatic switching of input channel.....	57
8.8.5	[C55] Setting forced output color mode.....	58
8.9	Displaying input/output statuses (Status display menu).....	59
8.9.1	[L00] Display selected input channel.....	59
8.9.2	[L01 to L13] Displaying digital input information	60
8.9.3	[L20 to L22] Displaying analog input information.....	62
8.9.4	[L30 to L60] Output information	63
9	Product specification	64
9.1	Specification.....	64
10	Troubleshooting.....	66

1 Included items

Make sure all items below are included in the package.
If any items are missing or damaged, please contact IDK.



One (1) HDC-TH200 (main unit)

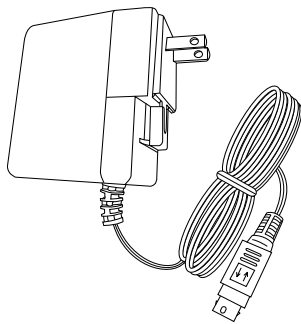

One (1) DIN plug AC adapter with locking mechanism

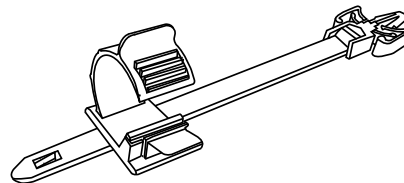

One (1) cord clamps

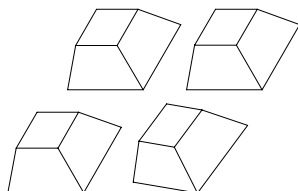

Four (4) rubber feet

[Fig. 1.1] Included items list

2 Product outline

The IDK HDC-TH200 is a transmitter for long-distance transmission of HDMI/DVI and Analog (video and audio) input signals over a twisted pair cable.

Since HDMI/DVI signals are transmitted without compression or processing, the image quality can be kept. Analog video signals can be converted to digital signal with high image quality by 12 bit quantization.

1 channel HDMI signal or DVIsignal and one channel analog input video signals (composite, Y/C (S-Video), RGB, and YPbPr) are supported. Selected input signal is converted to HDBaseT signal and output.

1 channel digital and analog audio is supported. Audio signal is embedded to video signal and transmit as HDBaseT signal.

The HDC has LAN port as communication port and HDBaseT signal support bidirectional LAN communication.

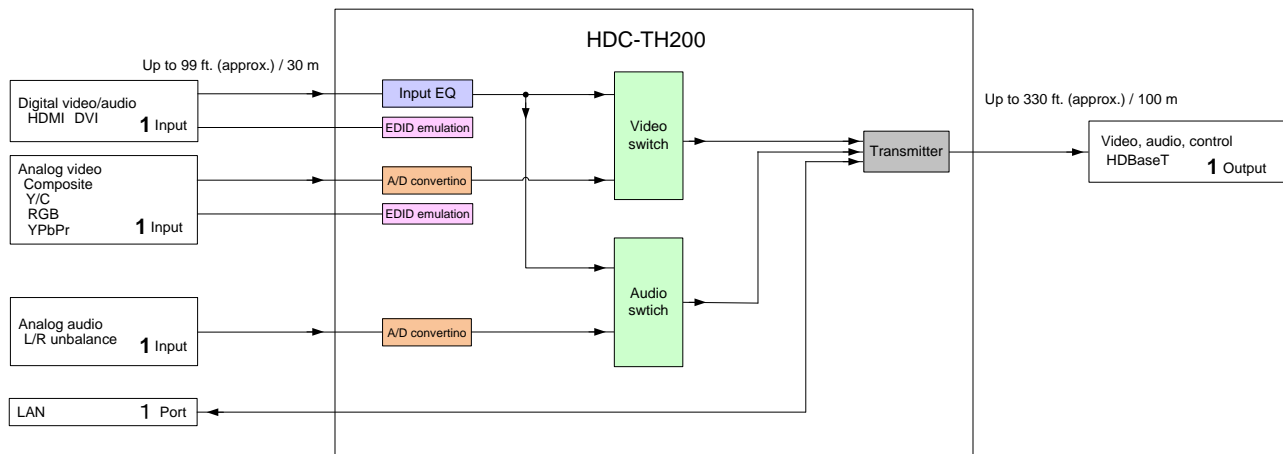

[Fig 2.1] Block diagram

3 Features

■ Video

- Up to QWXGA (RB)*1 or 1080p
- HDCP supported
- 3D Y/C separation for NTSC and PAL signals
- Digital cable EQ
INPUT: up to 33 ft. to 98.43 ft. / 10 m to 30 m
- Up to 328.08 ft. approx. / 100 m signal extension over a Cat6 cable
- Anti-snow

■ Audio

- Embedding analog audio into digital signals

■ Control output

- LAN (Bi-directional communication)

■ Others

- EDID emulation
- Auto input detection and switching
- CEC (Pass through)
- Last memory
- Connection Reset
- Front panel security lock out
- Lock mechanism for AC adapter

*1 (RB) = Reduced Blanking

4 Panels

4.1 Front panel

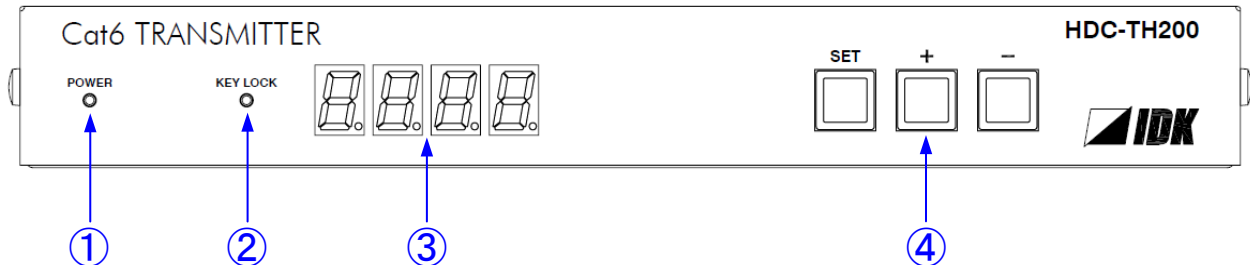

[Fig. 4.1] Front panel drawing

[Table 4.1] Front panel's part name and description

#	Part name	Description
①	POWER LED	Shows power status of the HDC ON: Power is supplied to the HDC OFF: Power is not supplied to the HDC
②	KEY LOCK LED	Shows key lock status of the HDC. ON: keys are locked Blink: during key lock setting OFF: keys are unlocked
③	Seven-segment LED	Displays menu number, setting number, and setting status.
④	Menu operation keys	Selects and sets each menu. If you press "SET" keys for a while you can lock / unlock keys. 【See: 7.1 Menu operations (P.22)】 【See: 7.2 Locking menu operation keys (P.23)】

4.2 Rear Panel

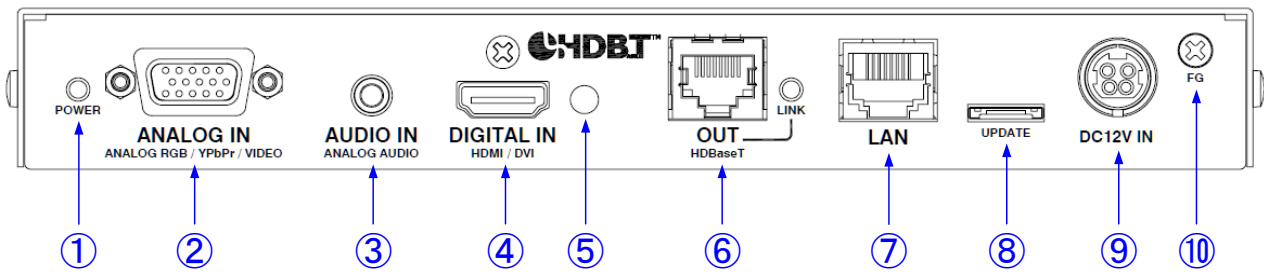

[Fig. 4.2] Rear panel drawing

[Table 4.2] Rear panel's part name and description

#	Part name	Description
①	POWER LED	Shows power status of the HDC ON: Power is supplied to the HDC OFF: Power is not supplied to the HDC
②	Analog video input connector	Input connector for analog video signal Following analog signals can be input. <ul style="list-style-type: none"> ▪ Analog RGB (such as PC) ▪ Analog YPbPr (SDTV / HDTV) ▪ Composite video (NTSC / PAL) ▪ S-Video (NTSC / PAL) 【See: 6.3.4 Analog video input connector (P.21)】
③	Audio input connector	Input connector for analog audio input
④	HDMI input connector	Input connector for HDMI signals. Connector for a source device such as a DVD/Blu-ray disc player.。
⑤	HDMI cable fixing hole	Holes for the supplied cable clamps to fix the HDMI cables. 【See: [Fig. 6.2] (P.17)】
⑥	HDBaseT output connector	Output connector for HDBaseT signal Connecting HDBaseT receivers using twisted pair cable. 【See: 6.3.2 Twisted pair cable (P.18)】
⑦	LAN port	LAN port connector. Connecting network devices.
⑧	Connector for maintenance	Not used. Please do not connect anything; this connector is for maintenance only.
⑨	DIN connector	Connecting attached AC adapter. 【See: 6.3.3 DIN plug AC adapter (P.19)】
⑩	Frame ground	Using M3 screw. Connecting ground terminal

5 Example connection

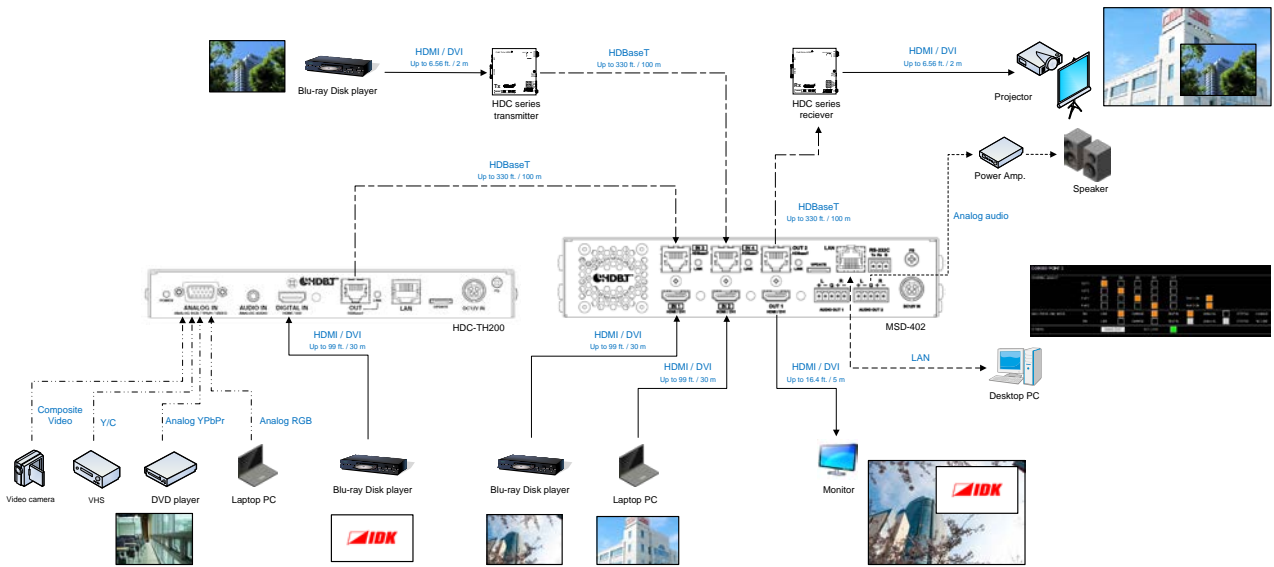

[Fig. 5.1] Source and sink devices are connected

6 Precautions

Before connecting to external devices, follow the precautions below.

6.1 Installing rubber feet

Please clean up the HDC main unit, and then install rubber feet to the four corners of the MSD.

6.2 Installation

When installing the HDC, please observe the following precautions.

- Do not place the HDC on top of another HDC.
- Do not block vent holes. Please secure the space above ambient 30 mm/1.18 inches.
- Do not install the HDC to an enclosed space. When the HDC needs to be installed to EIA rack mount or an enclosed space, please prepare ventilating equipment to keep the ambient temperature at 40 degrees C/104 degrees F or less. If inadequately vented, the life of parts may be shortened and operations may be affected.

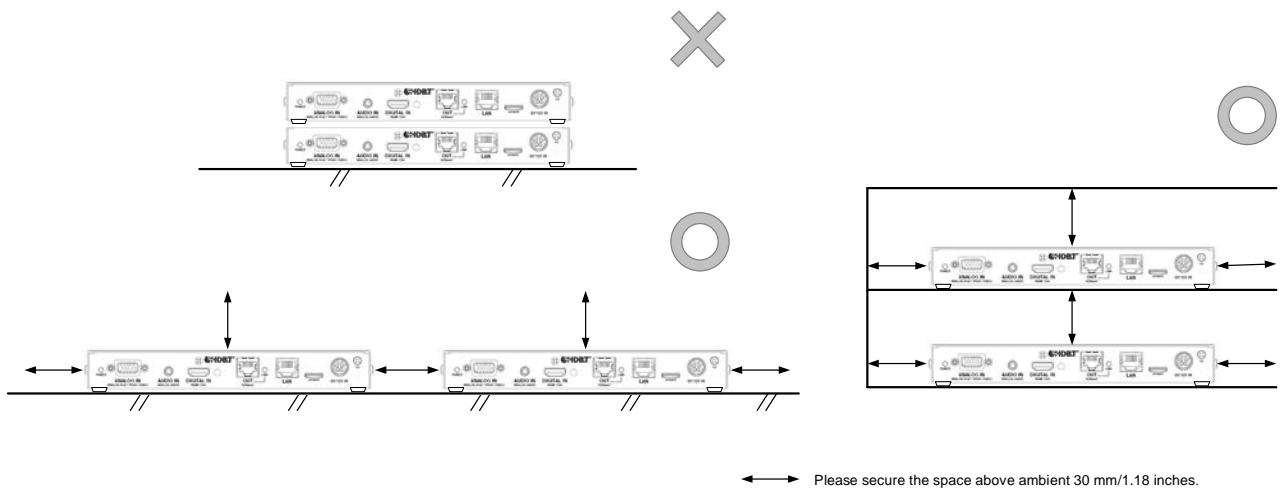

[Fig. 6.1] Spaces for installation

6.3 Cabling

When connecting the HDC to the external devices, please observe the following precautions.

- Read manuals of the external devices.
- Before you connect the cable to the HDC or an external device, please remove electrification of the body by touching the metal around that is grounded.
- Turn off all devices' power before connecting the cable.
- Be sure to plug cables completely and install them without any stress on connectors.
- Fix HDMI cables using cable clamps to prevent those cables from falling off.

Fixing HDMI cable using cable clamp

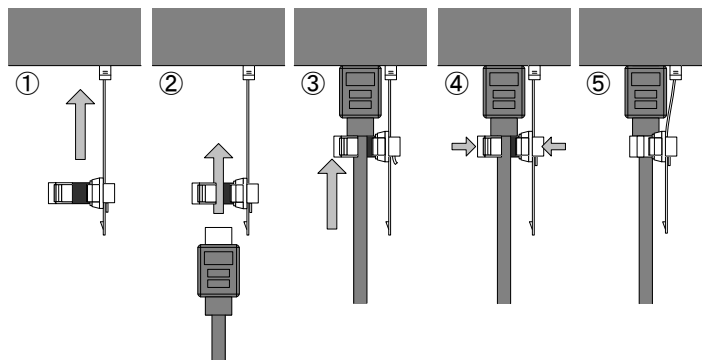

Removing HDMI cable and cable clamp

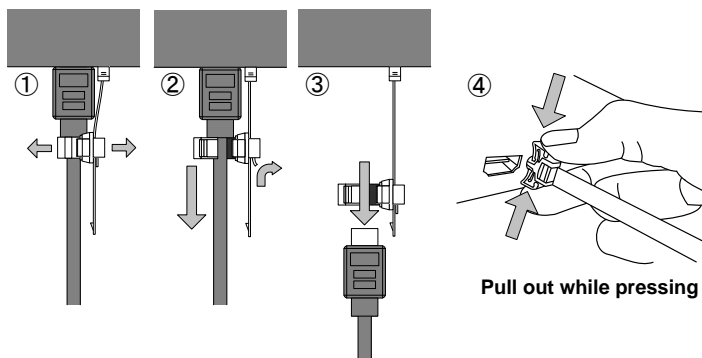

[Fig. 6.2] Attaching a cable clamp

6.3.1 Cables

IDK Corporation provides various digital cables such as HDMI, DVI, and twisted pair cables. Please choose appropriate cables for your system configuration.

6.3.2 Twisted pair cable

When connecting twisted pair cables to the MSD, please observe the following precautions.

- Cat5e/Cat6 UTP/STP can be used, however, we recommend a CAT.5E HDC cable* for the twisted pair cable which is developed by IDK to maximize quality of video transmission.
- If using an STP cable, connect the FG connector to an earth ground source. Otherwise, the shielding feature does not work correctly. When using a UTP cable, we still recommend using the ground connector.
- The shielded STP cables are less affected by interference or external noise than UTP cables.
- The connector for twisted pair cable is as same as the connectors which are used for Ethernet (8 core modular type connector), however, it cannot be connected and use for Ethernet because the way of data transmission is different.
- The maximum extension distance of Cat5e/Cat6 UTP/STP cable is the shorter maximum extension distance of the connected HDC receiver and sink device.
- For pin assignments, apply T568A or T568B standards for straight through wiring.
- Do not give connection cables a strong pull. The allowable tension of the twisted pair cable is 110 N.
- Do not bend the connection cable at a sharp angle. Keep the bend radius four times of the cable diameter or longer.
- Do not tie the cable tightly; leave a space allowing the cable to move slightly.
- If you use the same cables, we recommended keeping a distance between the cables or not to place the cables closely in parallel.
- Keep the twisted pair cable as straight as you can. If you coil the cable, it is easily affected by noise.
- Do not place this product in an electrically noisy environment, since high-speed signal is transmitted. Particularly when you use a high-output radio around this device, video or audio may be interrupted.
- If the distance between the transmitter and receiver is 100 m/328.08 feet or less, cables can be joined using an RJ-45 plug coupler or wall outlet. Up to two cable couplers are allowed. Couplers supporting Cat6A (10GBase-T) are recommended.
- [Figure 6.2] shows extension distance by each twisted pair cable. The extension distance depending on installation environment.

[Table 6.1] Twisted pair cable extension distance

External noise	Category		Distance	Dot clock	Memo
Affected	UTP	Cat5e	50 m/164.04 ft.	<= 225 MHz	IDK recommends Cat5e STP, Cat6 UTP/STP, or CAT.5E HDC cable* if the extension distance exceeds 50 m/164.04 ft.
		Cat6	100 m/328.08 ft.		
Less affected	STP	Cat5e*	100 m/328.08 ft.		
		Cat6			

* CAT.5E HDC cable developed by IDK Corporation is double shielded twisted pair cable for high quality video transmission. It protects video signal from external noise or other interferences by having double shielded structure. Its transmission characteristic meets 500 MHz up to 100 m/328.08 ft., and it is certified and recommended by HDBaseT alliance.

[NOTE] If there is a problem in the transmission path, video or audio may be interrupted. Please check the items above. If the problem still cannot be solved, shorten the length of the twisted pair cable.

6.3.3 DIN plug AC adapter

■ Attaching/removing AC plug

The AC plug for DIN plug AC adapter is different by each country. Please use appropriate AC plug.

Removing:

Removes AC plug by sliding AC plug from AC adapter main unit whole holding down the partial knob

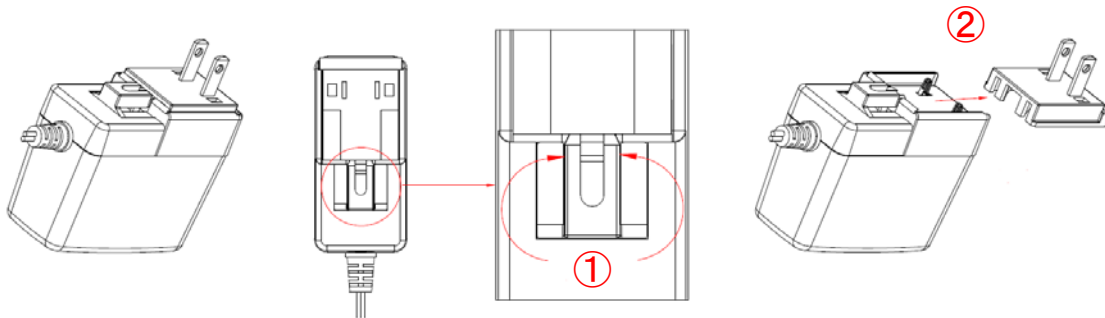

[Fig. 6.1] Removing AC plug

Attaching:

Slides in an AC plug to the AC adapter.

[NOTE] Please insert the tab to AC adapter.

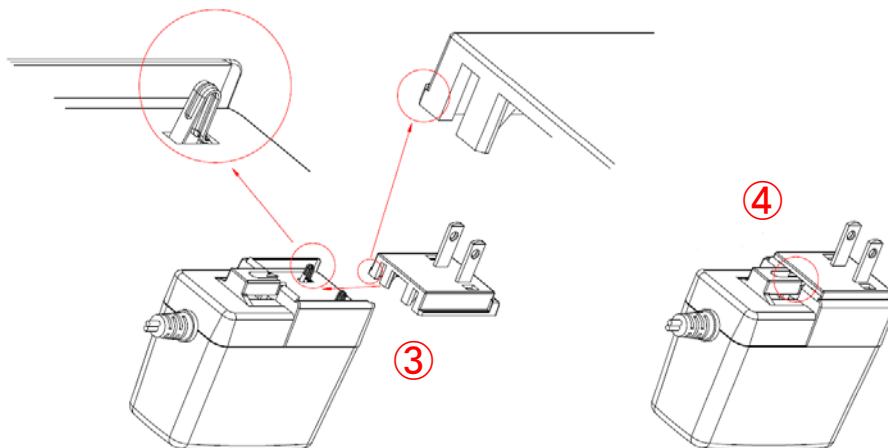

[Fig. 6.2] Attaching AC plug

■ **Connecting DC plug**

Please connect DC plug to the MSD until you can hear small sound of fixing. When you disconnect DC plug from the MSD, please hold the part which is specified in following figure.

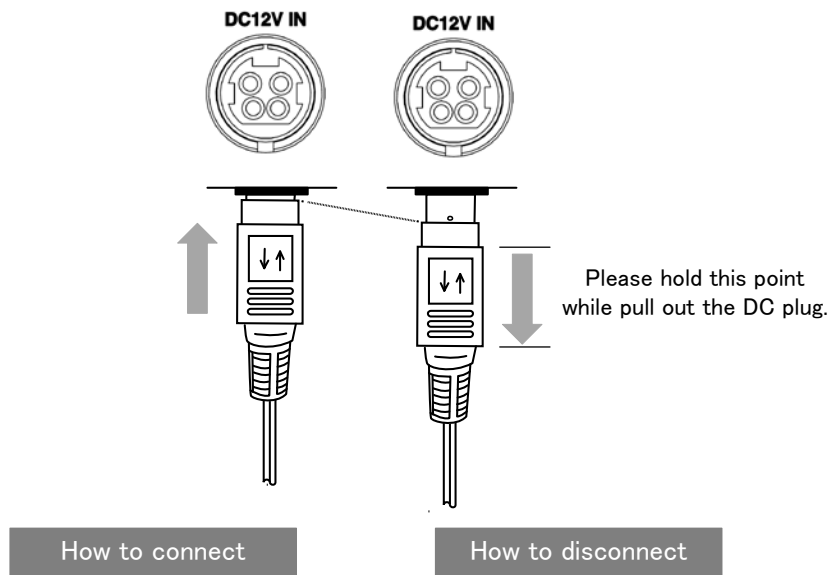

[Fig. 6.3] Connecting DC plug

6.3.4 Analog video input connector

D-sub15 pin connector is used and enables not only analog RGB signal (such as PC) to be input, but also analog YPbPr (SDTV/HDTV), composite video (NTSC/PAL), and S-video (NTSC/PAL) signal to be input using a conversion cable.

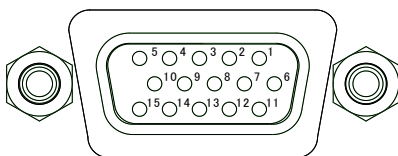

[Fig. 6.4] D-sub15 pin connector

[Table 6.6] Pin assignment

Pin #	Input signals			
	Analog RGB	Analog YPbPr	Composite video	S-Video (Y/C)
1	Red	Pr/Cr	N.C.	N.C.
2	Green	Y	VIDEO	Y
3	Blue	Pb/Cb	N.C.	C
4	N.C.	N.C.	N.C.	N.C.
5	GND	N.C.	N.C.	N.C.
6	GND	GND	N.C.	N.C.
7	GND	GND	GND	GND
8	GND	GND	N.C.	GND
9	N.C.	N.C.	N.C.	N.C.
10	GND	N.C.	N.C.	N.C.
11	N.C.	N.C.	N.C.	N.C.
12	DDC Data	N.C.	N.C.	N.C.
13	HD/CS	N.C.	N.C.	N.C.
14	VD	N.C.	N.C.	N.C.
15	DDC Clock	N.C.	N.C.	N.C.

N.C. : No Connection

6.3.5 Connection between HDC-TH200 and MSD-402

When HDC-TH200 is connected to the MSD-402 using HDBaseT signal, its input channels can be switched from the MSD-402. For the details please see User's Guide of MSD-402.

【See : 5 Example connection (P.15) 】

7 Basic operation

7.1 Menu operations

You can set all input/output settings of video and audio signals from menu operation keys.

Menu operation keys

Select the menu number first and then select the setting number.

If you do not operate for 10 seconds in step 5, you will go back to step 2.

If you do not operate for 60 seconds in each step, the light of the segment display will be turned off.

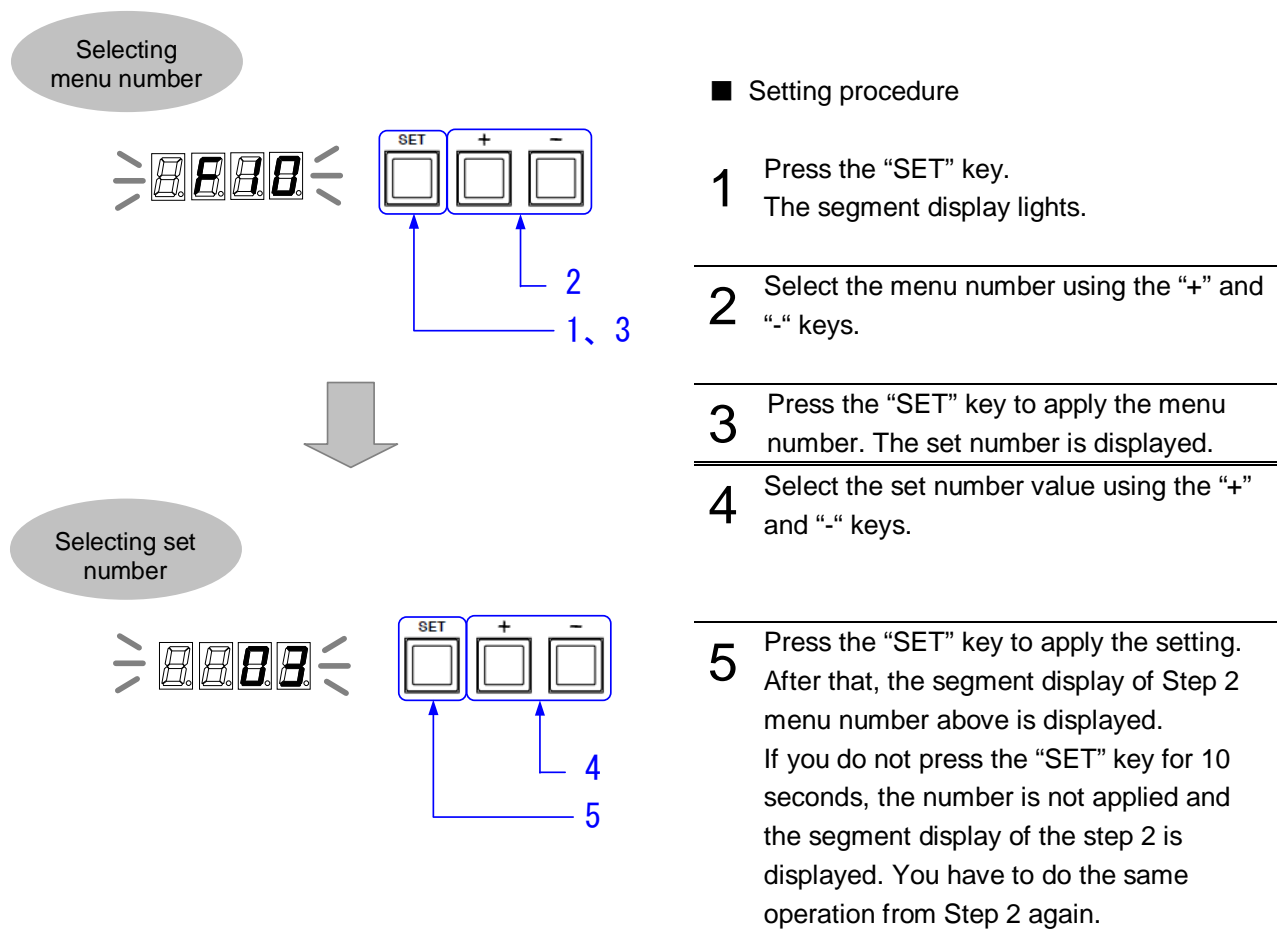

[Fig. 7.1] Menu key operation

7.2 Locking menu operation keys

Press and hold the "SET" key for 3 seconds or longer to set/cancel key lock.



Menu operation keys will be locked by pressing the "SET" key for three seconds.

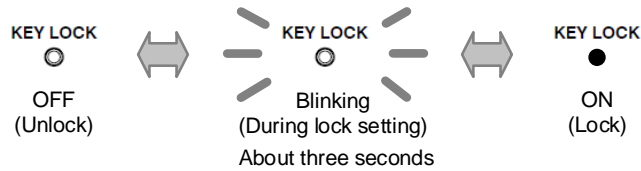

[Fig. 7.2] Locking menu operation keys

7.3 Initialization

All input and output settings will be initialized by powering on while pressing the "SET" key.

Note:

Once settings are initialized, they cannot be restored to the previous settings.



Turn ON the unit by pressing "SET" key.



Initialization is done

[Fig. 7.3] Initialization

8 Menus

- Setup menus: setting video and audio signals in normal use
- Maintenance menus: checking operation
- Status display menus: displaying statuses of input signals and connection with sink devices

Note:

Normally, the maintenance menu and status display menu are not displayed as a default.

[Table 8.1] Setup menus

Input switching settings	
[F00] Manual input channel switching (P.30)	[F06] Audio (P.29)
[F05] Priority of input channel automatic switching (P.28)	
Input settings	
[F16] No-signal input monitoring (P.31)	[F07] Analog input signal type (P.32)
[F17] Digital input eqlizer (P.31)	[F64] Color bit for analog video input (P.32)
EDID settings	
[F01] Copying EDID (P.33)	[F28] Setting Dolby Digital Plus Audio (P.38)
[F10 to F11] Setting EDID resolution (P.34)	[F30] Setting DTS Audi (P.38)
[F76 to F77] Setting EDID WXGA (P.35)	[F32] Setting DTS-HD Audi (P.39)
[F20] Setting Deep Color (P.36)	[F34] Setting Dolby TrueHD Audio (P.39)
[F22] Setting PCM Audio (P.36)	[F36] Setting Audio channel (P.40)
[F24] Setting AC-3 Dolby Digital Audio (P.36)	[F38] Copying CEC physical address copy of EDID (P.41)
[F26] Setting AAC Audio (P.37)	
Analog video timing settings	
[F08] Automatic measurement (P.42)	[F47] Horizontal sync signal width (P.49)
[F40] Analog video automatic adjustment (P.44)	[F48] Starting position of vertical lines (P.50)
[F42] Setting the total number of horizontal dots (P.46)	[F49] Vertical active area (P.50)
[F43] Starting position of horizontal dots (P.47)	[F50] Vertical display strat positoin (P.51)
[F44] Horizontal Active area (P.47)	[F51] Display period of vertical (P.51)
[F45] Horizontal display start position (P.48)	[F52] Vertical sync signal width (P.52)
[F46] Display period of horizontal dots (P.48)	[F53] Tracking (P.52)
Output settings	
[F65] Setting audio output (P.53)	[F70] Setting Deep Color output (P.53)
Others settings	
[F90] Displaying firmware version (P.54)	[F99] Setting maintenance/status display menu (P.54)

[NOTE]

Normally, the maintenance menu and status display menu are not displayed as a default.

To display them, use the setting menu number **8.7.2 [F99] Setting maintenance/status display menu (P.54)**

8.1 Menu list

■ Setup menu

[Table 8.2] Setup menus (1/2)

Menu number and functions	Setting		Page
	Setting value	Default	
[F00] Manual input channel switching	Digital input / Analog input	—	30
[F01] Copying EDID	Copy / No copy	No Copy	33
[F05] Priority of input channel automatic switching	Auto / Digital has priority / Analog has priority / Digital input fixed / Analog input fixed	Auto	28
[F06] Audio	Auto / Digital audio / Analog audio	Auto	29
[F07] Analog input signal type	Auto / Analog RGB / Analog YPbPr / Auto video / Composite video / S-Video	Auto	32
[F08] Automatic measurement	CLr / OFF / ON / 4:3 / 16:9 / 5:3 / 5:4 / 16:10	OFF	42
[F10 to F11] Setting EDID resolution	720p, 1080i, 1080p, SVGA to QWXGA	1080p	34
[F16] No-signal input monitoring	OFF / 2 to 15 [sec]	10 [sec]	31
[F17] Digital input equalizer	ON / OFF	ON	31
[F20] Setting Deep Color	8 / 10 / 12 [bit]	8 [bit]	36
[F22] Setting PCM Audio	32 / 44.1 / 48 / 88.2 / 96 / 192 [kHz]	48 [kHz]	36
[F24] Setting AC-3 Dolby Digital Audio	OFF / 32 / 44.1 / 48 [kHz]	OFF	36
[F26] Setting AAC Audio	OFF / 32 / 44.1 / 48 / 88.2 / 96 [kHz]	OFF	37
[F28] Setting Dolby Digital Plus Audio	OFF / 32 / 44.1 / 48 [kHz]	OFF	38
[F30] Setting DTS Audi	OFF / 32 / 44.1 / 48 / 96 [kHz]	OFF	38
[F32] Setting DTS-HD Audi	OFF / 44.1 / 48 / 88.2 / 96 / 176.4 / 192 [kHz]	OFF	39
[F34] Setting Dolby TrueHD Audio	OFF / 44.1 / 48 / 88.2 / 96 / 176.4 / 192 [kHz]	OFF	39
[F36] Setting Audio channel	2 channels / 3 (2.1 channels) / 6 (5.1 channels) / 8 (7.1 channels)	2 channels	40
[F38] Copying CEC physical address copy of EDID	Copy / No copy	No Copy	41

[Table 8.3] Setup menus (2/2)

Menu number and functions	Setting		Page
	Setting value	Default	
[F40] Analog video automatic adjustment	No auto adjustmnet / Auto adjustment mode 1 / Auto adjustment mode 2	Auto adjustment mode 1	44
[F42] Setting the total number of horizontal dots	400 to 4125 [dot]	—	46
[F43] Starting position of horizontal dots	20 to 2900 [dot]	—	47
[F44] Horizontal Active area	20 to 2900 [dot]	—	47
[F45] Horizontal display start position	20 to 2900 [dot]	—	48
[F46] Display period of horizontal dots	20 to 2900 [dot]	—	48
[F47] Horizontal sync signal width	9 to 360 [dot]	—	49
[F48] Starting position of vertical lines	10 to 2048 [line]	—	50
[F49] Vertical active area	10 to 2048 [line]	—	50
[F50] Vertical display strat positoin	10 to 2048 [line]	—	51
[F51] Display period of vertical	10 to 2048 [line]	—	51
[F52] Vertical sync signal width	1 to 20 [line]	—	52
[F53] Tracking	0 to 63	0	52
[F64] Color bit for analog video input	8 / 10 / 12 [bit]	8 [bit]	32
[F65] Setting audio output	ON / OFF	ON	53
[F70] Setting Deep Color output	8 / 10 / 12 [bit]	12 [bit]	53
[F76 to F77] Setting EDID WXGA	1360 x 768 / 1366 x 768	1360 x 768	35
[F90] Displaying firmware version	—	—	54
[F99] Setting maintenance/status display menu	Not displayed / Displayed / Always displayed	Not displayed	54

■ Maintenance menus

[Table 8.4] Maintenance menus

Menu number and functions	Setting		Page
	Setting value	Default	
[C01] Setting sink device EDID check	Always recognize as HDMI device / When EDID read error, recognize as HDMI device / When EDID read error, recognize as DVI device	When EDID read error, recognize as DVI device	55
[C06] Setting HDCP input	HDCP enable / HDCP disable	HDCP Enable	56
[C10] Setting how long hot plug is ignored	OFF / 2 to 15 [sec]	OFF	57
[C30] Masking time after automatic switching of input channel	OFF / 0.5 to 10 [sec]	1 [sec]	57
[C55] Setting forced output color mode	Auto / DVI output / RGB output / YCbCr422 output / YCbCr444 output	Auto	58

■ Status menus

[Table 8.5] Status menus

Menu number and functions	Setting		Page
	Setting value	Default	
[L00] Display selected input channel	—	—	59
[L01 to L13] Displaying digital input information	—	—	60 to 62
[L20 to L22] Displaying analog input information	—	—	62
[L30 to L60] Output information	—	—	63

8.2 Input switching setting

8.2.1 [F05] Priority of input channel automatic switching

Set value

- 00 : Auto [Default]
- 01 : Digital input has priority
- 02 : Analog input has priority
- 03 : Fixed digital input
- 04 : Fixed analog input

■ Auto

HDC-TH200 will switch input channel under following conditions:

- When new video signal is detected, HDC-TH200 switch the input channel to the detected channel
- When current selected channel loose signal and if another channel has video signal, HDC-TH200 switch the input channel to the channel which has video image.

Selected channel is memorized (last memory). When turn off the HDC having active input signals on Digital input and analog input, HDC will select the channel which is selected before turn off.

■ Digital input has priority

If HDC-TH200 detects both digital and analog video signal, it output digital output.

Only when there is no digital input but analog input, the HDC output analog video signal.

■ Analog input has priority

If HDC-TH200 detects both digital and analog video signal, it output analog output.

Only when there is no analog input but digital input, the HDC output digital video signal.

■ Fixed digital input

Always output digital video signal

■ Fixed analog input

Always output analog video signal

You can set masking time for automatic switching from **8.8.4 [C30] Masking time after automatic switching of input channel (P.57)**.

【See: 8.8.4 [C30] Masking time after automatic switching of input channel (P.57) 】

【NOTE】

This menu will be not available temporarily while you are displaying **8.2.3 [F00] Manual input channel switching (P.30)** or exevuting "CHANGE mode". Please see MSD-402 user's guide for "CHANGE mode".

8.2.2 [F06] Audio

Select audio which is embedded to video signal

Set value

- 00 : Auto (following video input) [Default]
- 01 : Digital audio (HDMI input connector)
- 02 : Analog audio (analog audio input connector)

【NOTE】

When you select digital audio setting and if the digital video signal has HDCP, the audio output has HDCP.

8.2.3 [F00] Manual input channel switching

You can switch input channel from front panel menu. “ - ” is assigned to digital input channel and “ + ” is assigned to analog input channel. During this menu is displayed automatic switching set by 8.2.1 [F05] **Priority of input channel automatic switching (P.28)** is disabled temporary.

For audio, setting follows 8.2.2 [F06] **Audio (P.29)**

- 00 : Auto (following video input) [Default]
- 01 : Digital audio (HDMI input connector)
- 02 : Analog audio (analog audio input connector)

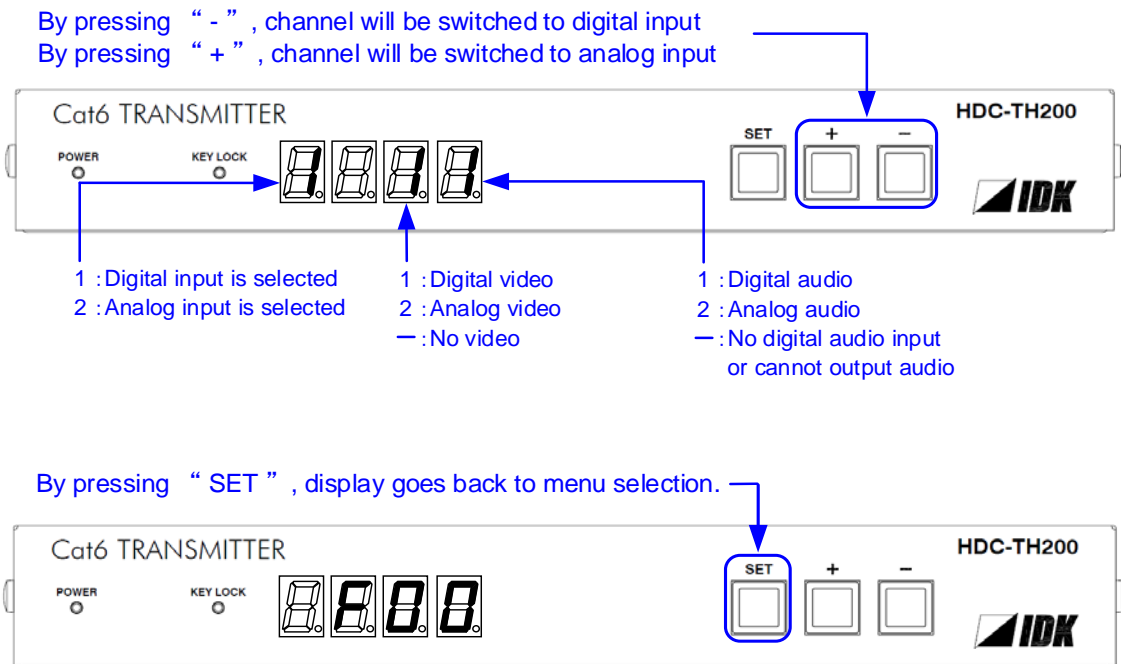

[Fig. 8.1] Manual input channel switching

[NOTE]

When you are executing “CHANGE mode” from MSD-402 and switch input channel from MSD-402, the display will correspond to the action.

While “CHANGE mode” is executing, setting of 8.2.1 [F05] **Priority of input channel automatic switching (P.28)** will be disabled temporary. Please see MSD-402 user's guide for “CHANGE mode”.

8.3 Input settings

8.3.1 [F16] No-signal input monitoring

If you change the settings of EDID of the HDC or turn off/on the HDC, the source device may not output video signal. Use this menu to set the monitoring time which is from when a source device stops outputting signal to when the HDC requests the source device to output video signal.

Set Value

oFF : OFF

02 to 15 : 2 seconds to 15 seconds [Default: 10 seconds]

【NOTE】

If you use the monitor power-saving function or Dual monitor function of the PC, set this menu to “oFF”. The PC that receives output request may cancel those functions.

If you set shorter time than the time which the source device outputs video, the source device may not output video. In such case, set the longer time.

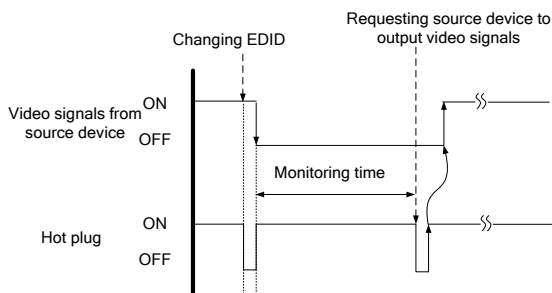

[Fig. 8.2] Monitoring absence of input

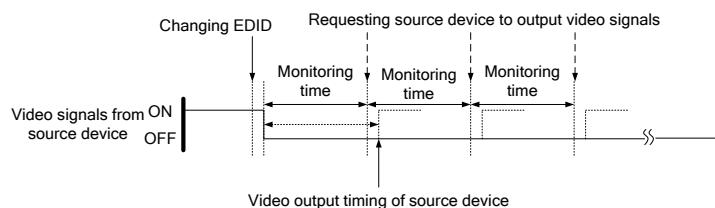

[Fig. 8.3] Repeating reset

8.3.2 [F17] Digital input eqlizer

Set Value

on : ON (Auto) [Default]

oFF : OFF

【NOTE】

If you use cables which are longer than 5 m / 16.4 ft., we recomned testing before actual installation. Also please set EQ “ON”.

8.3.3 [F07] Analog input signal type

You can set video type which is input to analog input connector. If there is no video input on analog input connector, " - - - " will be displayed.

Set Value

- 00 : Auto [Default]
- 01 : Analog RGB
- 02 : Analog YPbPr
- 03 : Auto video (Auto recognition between composite and S-Video)
- 04 : Composite video
- 05 : S-Video

【NOTE】

Usually if the HDC is set to "00" (Auto), HDC recognize input video signal automatically. However, it cannot be recognized input video image depending on signal condition sometimes, and then please select video type manually.

When you set to "00" (Auto), sometimes auto recognition for S-video is failed. If input signals are composite video and S-Video, please set to "03" (Auto video), and if input signal is only S-video, please set to "05" (S-video)

For the mono viode image or bad condition VHS, please set to "03" (Video auto), "04" (Composite video), or "05" (S-video).

8.3.4 [F64] Color bit for analog video input

Set value

- 08 : 8 bit [Default]
- 10 : 10 bit
- 12 : 12 bit

【NOTE】

To output Deep Color video image please set output coler depth to 10 bit or 12 bit from **8.6.2 [F70] Setting Deep Color output (P.53)**, and use sink device which support Deep Color.

8.4 EDID

8.4.1 [F01] Copying EDID

EDID of sink devices can be read and stored, and the copied EDID can apply in the same way of internal EDID.

Set value

- on : Copying EDID
- oFF : Not copying EDID [Default]

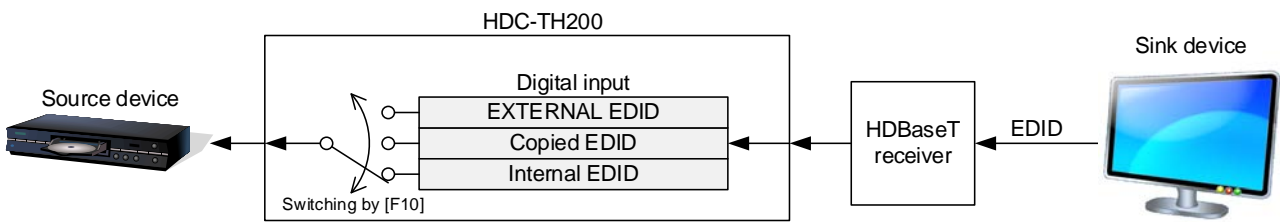

[Fig. 8.4] Copying EDID

Please see 8.4.2 [F10 to F11] Setting EDID resolution (P.34) to change EDID setting.

8.4.2 [F10 to F11] Setting EDID resolution

You can set the EDID to be sent to the source device:
EDID for digital input and analog input can be set individually.

“01 to 02” [F10] : Can be selected only for digital input

“03 to 22” are internal EDID which HDC-TH200 has.

Menu number

F10 : Digital input

F11 : Analog input

Set value

[Table 8.6] The maximum resolution of EDID, [Table 8.7] The maximum resolution and EDID supported pixels

[Table 8.6] The maximum resolution of EDID

Setting values	Maximum resolution	Pixel	Standard	Remarks
01	EXTERNAL (ExternalEDID)	—	—	If no sink device is connected, the previous setting will be applied. If no collected data, its default is 03.
02	Copy EDID	—	—	Copied EDID which is set in 8.4.1 [F01] Copying EDID (P.33) If no collected data, its default is 03.
03	1080p (59.94/60)	1920 × 1080	HDTV	[Default]
04	720p	1280 × 720		
05	1080i	1920 × 1080		
06	1080p (24/25/30/50)	1920 × 1080		
07	SVGA	800 × 600	VESA	
08	XGA	1024 × 768		
09	VESA720	1280 × 720	CVT	For DVI device input
10	WXGA	1280 × 768	VESA	
11	WXGA	1280 × 800		For MAC
12	Quad-VGA	1280 × 960		
13	SXGA	1280 × 1024		
14	WXGA	1360 × 768、 1366 × 768		The number of pixels can be set in [F76 to F77] Setting EDID WXGA (P.35)
15	SXGA+	1400 × 1050		
16	WXGA+	1440 × 900		
17	WXGA++	1600 × 900		(RB)
18	UXGA	1600 × 1200		
19	WSXGA+	1680 × 1050		
20	VESA1080	1920 × 1080	CVT	(RB), For DVI device input
21	WUXGA	1920 × 1200	VESA	(RB)
22	QWXGA	2048 × 1152		(RB)

(RB) : Reduced Blanking

[See : 8.4.3 [F76 to F77] Setting EDID WXGA (P.35)]

[Table 8.7] The maximum resolution and EDID supported pixels

EDID supported Pixels		640x480	800x600	1024x768	1280x720	1280x768	1280x800	1280x960	1280x1024	1360x768*	1366x768*	1400x1050	1440x900	1600x900	1600x1200	1680x1050	1920x1080	1920x1200	2048x1152	
Max. resolution (Setting values)																				
03	1080p(59.94/60)	Y	Y	Y	N	N	Y	Y	Y	Y	Y	Y	Y	Y	Y	Y	Y	N	N	
04	720p	Y	Y	N	Y	N	N	N	N	N	N	N	N	N	N	N	N	N	N	N
05	1080i	Y	Y	Y	N	N	N	N	N	N	N	N	N	N	N	N	N	N	N	N
06	1080p (24/25/30p/50p)	Y	Y	Y	N	N	Y	Y	Y	Y	Y	Y	Y	Y	Y	Y	Y	N	N	
07	800x600	Y	Y	N	N	N	N	N	N	N	N	N	N	N	N	N	N	N	N	N
08	1024x768	Y	Y	Y	N	N	N	N	N	N	N	N	N	N	N	N	N	N	N	N
09	1280x720	Y	Y	Y	Y	N	N	N	N	N	N	N	N	N	N	N	N	N	N	N
10	1280x768	Y	Y	Y	Y	Y	N	N	N	N	N	N	N	N	N	N	N	N	N	N
11	1280x800	Y	Y	Y	Y	Y	Y	N	N	N	N	N	N	N	N	N	N	N	N	N
12	1280x960	Y	Y	Y	Y	Y	Y	Y	N	N	N	N	N	N	N	N	N	N	N	N
13	1280x1024	Y	Y	Y	Y	Y	Y	Y	Y	N	N	N	N	N	N	N	N	N	N	N
14	1360x768 ※	Y	Y	Y	Y	Y	Y	Y	Y	Y	Y	N	N	N	N	N	N	N	N	N
15	1400x1050	Y	Y	Y	Y	N	Y	Y	Y	Y	Y	Y	N	N	N	N	N	N	N	N
16	1440x900	Y	Y	Y	Y	N	Y	Y	Y	Y	Y	Y	Y	N	N	N	N	N	N	N
17	1600x900	Y	Y	Y	Y	N	Y	Y	Y	Y	Y	Y	Y	Y	N	N	N	N	N	N
18	1600x1200	Y	Y	Y	Y	N	Y	Y	Y	Y	Y	Y	Y	Y	Y	N	N	N	N	N
19	1680x1050	Y	Y	Y	Y	N	Y	Y	Y	Y	Y	Y	Y	Y	Y	Y	N	N	N	N
20	1920x1080	Y	Y	Y	N	N	Y	Y	Y	Y	Y	Y	Y	Y	Y	Y	Y	N	N	N
21	1920x1200	Y	Y	Y	N	N	Y	Y	Y	N	N	Y	Y	Y	Y	Y	Y	Y	Y	N
22	2048x1152	Y	Y	Y	N	N	N	Y	Y	N	N	Y	Y	Y	Y	Y	Y	Y	Y	Y

Y : Supported, N : Not supported

1360x768 and 1366x768 can be selected in **8.4.3 [F76 to F77] Setting EDID WXGA (P.35)**

8.4.3 [F76 to F77] Setting EDID WXGA

You can set the number of WXGA pixels based on the resolution setting of EDID.

【See : 8.4.2 [F10 to F11] Setting EDID resolution (P.34) 】

Menu number

F76 : Digital input

F77 : Analog input

Set value

on : 1366 x 768

oFF : 1360 x 768 [Default]

8.4.4 [F20] Setting Deep Color

You can set the Deep Color (color depth) that is output from the source device.

Set value

- 08 : 8 bit [Default]
- 10 : 10 bit
- 12 : 12 bit

【NOTE】

This setting is only for digital input EDID. The setting will be applied only if one of 03 to 22 is selected for **8.4.2 [F10 to F11] Setting EDID resolution (P.34)**. To output Deep Color, please set 10 bit or 12 bit in **8.6.2 [F70] Setting Deep Color output (P.53)** and connect sink devices which support Deep Color.

8.4.5 [F22] Setting PCM Audio

You can set the maximum sampling frequency of PCM Audio that is output from the source device.

Set value

- 32 : 32 kHz
- 44 : 44.1 kHz
- 48 : 48 kHz [Default]
- 88 : 88.2 kHz
- 96 : 96 kHz
- 192 : 192 kHz

【NOTE】

This setting is only for digital input EDID. The setting will be applied only if one of 03 to 22 is selected for **8.4.2 [F10 to F11] Setting EDID resolution (P.34)**. Depending on sink devices, there are audio format which are not supported on sink device. Please select supported audio format and frequency.

8.4.6 [F24] Setting AC-3 Dolby Digital Audio

You can set the maximum sampling frequency of AC-3 Dolby Digital Audio that is output from the source device.

Set value

32 : 32 kHz
44 : 44.1 kHz
48 : 48 kHz
oFF : OFF [Default]

【NOTE】

This setting is only for digital input EDID. The setting will be applied only if one of 03 to 22 is selected for **8.4.2 [F10 to F11] Setting EDID resolution (P.34)**. Depending on sink devices, there are audio format which are not supported on sink device. Please select supported audio format and frequency.

8.4.7 [F26] Setting AAC Audio

You can set the maximum sampling frequency of AAC Audio that is output from the source device.

Set value

32 : 32 kHz
44 : 44.1 kHz
48 : 48 kHz
88 : 88.2 kHz
96 : 96 kHz
oFF : OFF [Default]

【NOTE】

This setting is only for digital input EDID. The setting will be applied only if one of 03 to 22 is selected for **8.4.2 [F10 to F11] Setting EDID resolution (P.34)**. Depending on sink devices, there are audio format which are not supported on sink device. Please select supported audio format and frequency.

8.4.8 [F28] Setting Dolby Digital Plus Audio

You can set the maximum sampling frequency of Dolby Digital Plus Audio that is output from the source device.

Set value

32 : 32 kHz
44 : 44.1 kHz
48 : 48 kHz
oFF : OFF [Default]

【NOTE】

This setting is only for digital input EDID. The setting will be applied only if one of 03 to 22 is selected for **8.4.2 [F10 to F11] Setting EDID resolution (P.34)**. Depending on sink devices, there are audio format which are not supported on sink device. Please select supported audio format and frequency.

8.4.9 [F30] Setting DTS Audio

You can set the maximum sampling frequency of DTS Audio that is output from the source device.

Set value

32 : 32 kHz
44 : 44.1 kHz
48 : 48 kHz
96 : 96 kHz
oFF : OFF [Default]

【NOTE】

This setting is only for digital input EDID. The setting will be applied only if one of 03 to 22 is selected for **8.4.2 [F10 to F11] Setting EDID resolution (P.34)**. Depending on sink devices, there are audio format which are not supported on sink device. Please select supported audio format and frequency.

8.4.10 [F32] Setting DTS-HD Audio

You can set the maximum sampling frequency of DTS-HD Audio that is output from the source device.

Set value

44 : 44.1 kHz
48 : 48 kHz
88 : 88.2 kHz
96 : 96 kHz
176 : 176.4 kHz
192 : 192 kHz
oFF : OFF [Default]

【NOTE】

This setting is only for digital input EDID. The setting will be applied only if one of 03 to 22 is selected for **8.4.2 [F10 to F11] Setting EDID resolution (P.34)**. Depending on sink devices, there are audio format which are not supported on sink device. Please select supported audio format and frequency.

8.4.11 [F34] Setting Dolby TrueHD Audio

You can set the maximum sampling frequency of Dolby TrueHD Audio that is output from the source device.

Set value

44 : 44.1 kHz
48 : 48 kHz
88 : 88.2 kHz
96 : 96 kHz
176 : 176.4 kHz
192 : 192 kHz
oFF : OFF [Default]

【NOTE】

This setting is only for digital input EDID. The setting will be applied only if one of 03 to 22 is selected for **8.4.2 [F10 to F11] Setting EDID resolution (P.34)**. Depending on sink devices, there are audio format which are not supported on sink device. Please select supported audio format and frequency.

8.4.12 [F36] Setting Audio channel

You can set the number of channels for the multiple-channel audio that is output from the source device.

Set value

- 02 : 2 channels [Default]
- 03 : 3 channels (2.1 channels)
- 06 : 6 channels (5.1 channels)
- 08 : 8 channels (7.1 channels)

■ The number of channels and speaker configuration

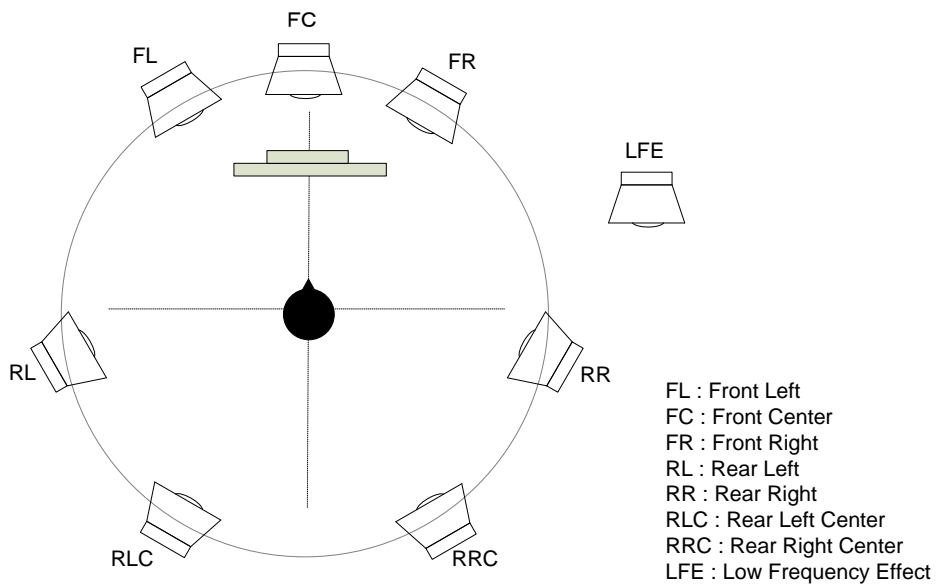

Speakers	FL / FR	LFE	FC	RL / RR	RLC / RRC
2 (2 channels)	ON	OFF	OFF	OFF	OFF
3 (2.1 channels)	ON	ON	OFF	OFF	OFF
6 (5.1 channels)	ON	ON	ON	ON	OFF
8 (7.1 channels)	ON	ON	ON	ON	ON

[Fig. 8.5] The number of channels and speaker configuration

[NOTE]

The setting will be applied only if one of 03 to 22 is selected for **8.4.2 [F10 to F11] Setting EDID resolution (P.34)**.

8.4.13 [F38] Copying CEC physical address copy of EDID

CEC: Pass through between HDMI input connector and HDBaseT output connector.

The CEC physical address of the sink device that is connected to HDBaseT output connector can be copied into the EDID of the HDC-TH200 HDMI input connector.

If the CEC physical address of the connected sink device and the HDC's address are not the same, the CEC functions, such as input switching in the sink device at start-up, may not work correctly. The problem can be solved by using the CEC physical address that is copied into the HDC.

Set value

- on : Copy physical address
- oFF : Not copy physical address [Default]

[NOTE]

The setting will be applied only if one of 03 to 22 is selected for **8.4.2 [F10 to F11] Setting EDID resolution (P.34)** and CEC supported source and sink devices are connected. CEC system link functions supported by other companies are not guaranteed to work correctly by this setting. Check the actual configuration.

8.5 Setting analog video timing

8.5.1 [F08] Automatic measurement

Analog RGB/analog YPbPr input video is measured to set automatically.

The HDC-TH200 has standard video timing formats settings. Normally the HDC recognize video input signals and use pre-registered standard timing formats.

This menu is used for if the HDC cannot recognize video format or video is not recognized correctly with standard timing formats.

If composite / S-video signal is input, only "CLr" and "oFF" are available.

If there is no analog input, this menu shows "- -".

Set value

- CLr : initializing timing format setting for current input signal
- oFF : do not change current timing format setting [Default]
- on : Auto recognized aspect ratio (4:3, 16:9, 5:3, 5:4, or 16:10)
- 4.3 : executing automatic measurement with 4:3 aspect ratio
- 16.9 : executing automatic measurement with 16:9 aspect ratio
- 5.3 : executing automatic measurement with 5:3 aspect ratio
- 5.4 : executing automatic measurement with 5:4 aspect ratio
- 16.10 : executing automatic measurement with 16:10 aspect ratio

●Can be measured:

- Input video contacts the circumscribed rectangle.
- Brightness of input video is 25% or more.

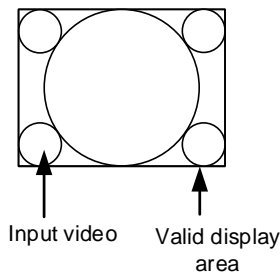

●Cannot be measured:

- Right and left sides of input video do not touch the circumscribed rectangle.
- Brightness of input video is 24% or less.

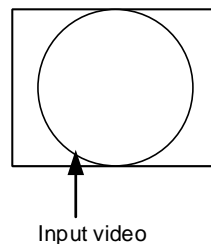
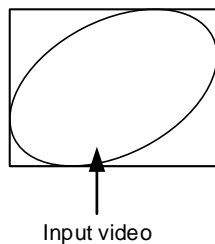

[Fig. 8.6] Condition for automatic measurement

Normal automatic measurement is executed with “on” setting.

If unknown video format is input to the unit, the aspect ratio might not match with normal automatic measurement. In this case, please select the menu which has correct aspect ratio automatic measurement setting.

The resolution horizontal direction, output dot clock will be adjusted from 25 MHz to 165 MHz. Because of this the actual resolution is going to be different from specified aspect ratio.

[Table 8.8] Video timing which is set by automatic measurement

Video timing which is set by automatic measurement	
[F42] Setting the total number of horizontal dots (P.46)	[F48] Starting position of vertical lines (P.50)
[F43] Starting position of horizontal dots (P.47)	[F49] Vertical active area (P.50)
[F44] Horizontal Active area (P.47)	[F50] Vertical display strat positoin (P.51)
[F45] Horizontal display start position (P.48)	[F51] Display period of vertical (P.51)
[F46] Display period of horizontal dots (P.48)	[F52] Vertical sync signal width (P.52)
[F47] Horizontal sync signal width (P.49)	[F53] Tracking (P.52)

The timing settings which are executed automatic measurement are registered to the HDC. If the same timing is input to the HDC next time, the HDC automatically load the registered timing setting and use it.

The timing settings are saved up to 127 settings.

#	Format	Timing settings
1	1080p 60Hz	
2	720p 50Hz	
3	480i 59.9Hz	
4	XGA 60Hz	
5	SXGA 60Hz	
⋮	⋮	
126	1080p 50Hz	
127	VGA 60Hz	

Timing settings are saved up to 127.
If settings are loaded, the priority number will be changed.

Older timing format will be deleted when the registered timing settings are exceed 127.

[Fig. 8.7] Timing settings

Timing settings are saved when the setting of [F42] to [F53] are changed also.

8.5.2 [F40] Analog video automatic adjustment

You can set automatic adjustment for analog video input. Automatic adjustment function will adjust input signal to center automatically by monitoring analog input video signal.

Set value

- oFF : no automatic adjustment to current input video
- on1 : executing automatic "adjustment mode1" [Default]
- on2 : executing automatic "adjustment mode2"

Automatic adjustment is available only when analog RGB / analog YPbPr video signals are input.

If the input signal is Composite video / S-Vide, only "oFF" is displayed.

If there is no analog video input, the HDC show "- - -".

This menu adjust video image by monitoring the area which the brightness is more than 25%.

● Automatic adjustment mode1

Adjusting without changing display period.

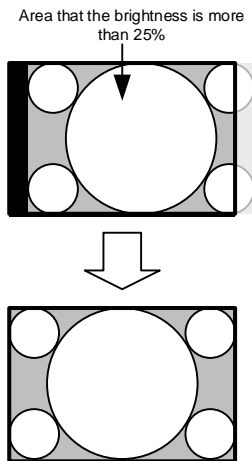

● Automatic adjustment mode2

Adjusting depending on area that the brightness is more than 25%.

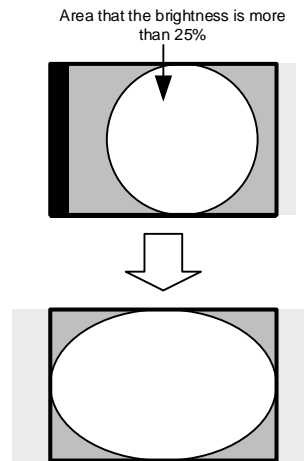

[Fig. 8.8] Automatic adjustment mode

[Table 8.9] Video timings which are adjusted by automatic adjustment mode

Settings adjusted by automatic measurement mode 1	Settings adjusted by automatic measurement mode 2
[F43] Starting position of horizontal dots (P.47) [F44] Horizontal Active area (P.47)	[F43] Starting position of horizontal dots (P.47) [F44] Horizontal Active area (P.47)
[F48] Starting position of vertical lines (P.50) [F49] Vertical active area (P.50)	[F46] Display period of horizontal dots (P.48) [F48] Starting position of vertical lines (P.50) [F49] Vertical active area (P.50)
[F53] Tracking (P.52)	[F51] Display period of vertical (P.51) [F53] Tracking (P.52)

【NOTE】

Depending on contents such as movie, sometimes display position will be moved because of automatic measurement. In this case, please set automatic adjustment to "oFF".

If you change setting from [F42] to [F53] manually, the manual settings will have priority and automatic adjustment is going to be "oFF".

8.5.3 [F42] Setting the total number of horizontal dots

You can set the total number of horizontal dots of analog RGB/analog YPbPr input video.

Set value

400 to 4125 : 400 dots to 4125 dots

Set value will be limited by sampling clock range from 13 MHz to 165 MHz.

The bottom values are different between starting position of horizontal dots and display period of horizontal dots. The bottom value is going to be "starting position of horizontal dots + display period of horizontal dots +1".

【See: 8.5.6 [F45] Horizontal display start position (P.48)】

【See: 8.5.7 [F46] Display period of horizontal dots (P.48)】

【NOTE】

When you change this setting by using "+" and "-" buttons the LED blinks. During the LED is blinking, press "SET" button and changes are executed.

If you do not operate more than 10 seconds during the LDE blinking, changes are not executed.

This menu is only available when analog RGB / analog YPbPr video input is input.

If Composite and S-video are input, it shows the total number of horizontal dots and cannot change settings.

If there is no analog signal, it shows "- -" and cannot change settings.

8.5.4 [F43] Starting position of horizontal dots

You can set starting position of horizontal dots for analog video input.

Set value

20 to 2900 : 20 dots to 2900 dots

Setting range is limited by starting position of horizontal dots, display period of horizontal dots, and frequency of horizontal dots.

Maximum setting value is "starting position of horizontal dots + display period of horizontal dots"

Minimum setting value is "frequency of horizontal dots + 1".

【See: 8.5.6 [F45] Horizontal display start position (P.48)】

【See: 8.5.7 [F46] Display period of horizontal dots (P.48)】

【See: 8.5.8 [F47] Horizontal sync signal width (P.49)】

【NOTE】

When you change this setting by using "+" and "-" buttons the LED blinks. During the LED is blinking, press "SET" button and changes are executed.

If you do not operate more than 10 seconds during the LED blinking, changes are not executed.

If there is no analog signal, it shows "--" and cannot change settings.

8.5.5 [F44] Horizontal Active area

You can set horizontal active area.

Set value

20 to 2900 : 20 dots to 2900 dots

Setting range is limited by setting of display period of horizontal dots.

Maximum value is "display period of horizontal dots"

【See: 8.5.7 [F46] Display period of horizontal dots (P.48)】

【NOTE】

When you change this setting by using "+" and "-" buttons the LED blinks. During the LED is blinking, press "SET" button and changes are executed.

If you do not operate more than 10 seconds during the LED blinking, changes are not executed.

If there is no analog signal, it shows "--" and cannot change settings.

8.5.6 [F45] Horizontal display start position

You can set horizontal display start position for analog input.

Set value

20 to 2900 : 20 dots to 2900 dots

Setting range is limited by total number of horizontal dots, display period of horizontal dots, and frequency of horizontal dots.

Maximum setting value is "total number of horizontal dots - display period of horizontal dots - 1"

Minimum setting value is "frequency of horizontal dots + 1".

【See: 8.5.3 [F42] Setting the total number of horizontal dots (P.46)】

【See: 8.5.7 [F46] Display period of horizontal dots (P.48)】

【See: 8.5.8 [F47] Horizontal sync signal width (P.49)】

【NOTE】

When you change this setting by using "+" and "-" buttons the LED blinks. During the LED is blinking, press "SET" button and changes are executed.

If you do not operate more than 10 seconds during the LED blinking, changes are not executed.

If there is no analog signal, it shows "- - -" and cannot change settings.

8.5.7 [F46] Display period of horizontal dots

You can set display period of horizontal dots.

Set value

20 to 2900 : 20 dots to 2900 dots

Setting range is limited by total number of horizontal dots and horizontal display start position.

Maximum setting value is "total number of horizontal dots - horizontal display start position - 1"

【See: 8.5.3 [F42] Setting the total number of horizontal dots (P.46)】

【See: 8.5.6 [F45] Horizontal display start position (P.48)】

【NOTE】

When you change this setting by using "+" and "-" buttons the LED blinks. During the LED is blinking, press "SET" button and changes are executed.

If you do not operate more than 10 seconds during the LED blinking, changes are not executed.

If there is no analog signal, it shows "- - -" and cannot change settings.

8.5.8 [F47] Horizontal sync signal width

You can set horizontal sync signal width for analog video input.

Set value

9 to 360 : 9 dots to 360 dots

Setting range is limited by horizontal display start position.

Maximum setting value is "horizontal display start position -1"

【See: 8.5.6 [F45] Horizontal display start position (P.48)】

【NOTE】

When you change this setting by using "+" and "-" buttons the LED blinks. During the LED is blinking, press "SET" button and changes are executed.

If you do not operate more than 10 seconds during the LED blinking, changes are not executed.

If there is no analog signal, it shows "--" and cannot change settings.

8.5.9 [F48] Starting position of vertical lines

You can set starting position of vertical lines for analog video input.

Set value

10 to 2048 : 10 lines to 2048 lines

Setting range is limited by vertical display start position, display period of vertical lines, and vertical sync signal width.

Maximum setting value is "vertical display start position + display period of vertical lines"

Minimum setting value is "vertical sync signal width +1".

【See: 8.5.11 [F50] Vertical display start position (P.51)】

【See: 8.5.12 [F51] Display period of vertical (P.51)】

【See: 8.5.13 [F52] Vertical sync signal width (P.52)】

【NOTE】

When you change this setting by using "+" and "-" buttons the LED blinks. During the LED is blinking, press "SET" button and changes are executed.

If you do not operate more than 10 seconds during the LED blinking, changes are not executed.

If there is no analog signal, it shows "--" and cannot change settings.

8.5.10 [F49] Vertical active area

You can set vertical active area for analog signal.

Set value

10 to 2048 : 10 lines to 2048 lines

Setting range is limited by display period of vertical lines.

Maximum setting value is "display period of vertical lines"

【See: 8.5.12 [F51] Display period of vertical (P.51)】

【NOTE】

When you change this setting by using "+" and "-" buttons the LED blinks. During the LED is blinking, press "SET" button and changes are executed.

If you do not operate more than 10 seconds during the LED blinking, changes are not executed.

If there is no analog signal, it shows "--" and cannot change settings.

8.5.11 [F50] Vertical display strat positoin

You can set vertical display strat position for analog video input.

Set value

10 to 2048 : 10 lines to 2048 lines

Setting range is limited by total number of vertical lines, display period of vertical lines, and vertical sync signal width.

Maximum setting value is "total number of vertical lines - display period of vertical lines -1".

Minimum setting value is "vertical sync signal width +1".

【See: 8.5.12 [F51] Display period of vertical (P.51)】

【See: 8.5.13 [F52] Vertical sync signal width (P.52)】

【NOTE】

When you change this setting by using "+" and "-" buttons the LED blinks. During the LED is blinking, press "SET" button and changes are executed.

If you do not operate more than 10 seconds during the LDE blinking, changes are not executed.

If there is no alalog signal, it shows "- -" and cannot change settings.

8.5.12 [F51] Display period of vertical lines

You can set display period of vertical dots for analog video input.

Set value

10 to 2048 : 10 lines to 2048 lines

Setting range is limited by total number of vertical lines and vertical display start position.

Maximum setting value is "total number of vertical lines – vertical display start position -1".

【See: 8.5.11 [F50] Vertical display strat positoin (P.51)】

【NOTE】

When you change this setting by using "+" and "-" buttons the LED blinks. During the LED is blinking, press "SET" button and changes are executed.

If you do not operate more than 10 seconds during the LDE blinking, changes are not executed.

If there is no alalog signal, it shows "- -" and cannot change settings.

8.5.13 [F52] Vertical sync signal width

You can set vertical sync signal width for analog video input.

Set value

1 to 20 : 1 line to 20 lines

Setting range is limited by vertical display start position.

Maximum setting value is "vertical display start position -1".

【See: 8.5.11 [F50] Vertical display start position (P.51)】

【NOTE】

When you change this setting by using "+" and "-" buttons the LED blinks. During the LED is blinking, press "SET" button and changes are executed.

If you do not operate more than 10 seconds during the LED blinking, changes are not executed.

If there is no analog signal, it shows "--" and cannot change settings.

8.5.14 [F53] Tracking

You can set tracking for analog RGB / analog YPbPr video input.

Please set appropriate numbers.

Set value

0 to 63 : 0 [Default]

【NOTE】

When you change this setting by using "+" and "-" buttons the LED blinks. During the LED is blinking, press "SET" button and changes are executed.

If you do not operate more than 10 seconds during the LED blinking, changes are not executed.

This menu is only available when analog RGB / analog YPbPr video input is input.

If Composite and S-video are input, it shows "0" and cannot change settings.

If there is no analog signal, it shows "--" and cannot change settings.

8.6 Output settings

8.6.1 [F65] Setting audio output

You can set audio output ON / OFF.

Set value

on : ON [Default]
oFF : OFF

8.6.2 [F70] Setting Deep Color output

You can set output color depth.

Set value

08 : 8 bit
10 : 10 bit
12 : 12 bit [Default]

To output Deep Color video image, please set this menu to 10 bit or 12 bit, and connect source and sink devices which support Deep Color.

For input signals, following conditions are applied:

Digital input video:

Source device has to output Deep Color video image and setting in **8.4.4 [F20] Setting Deep Color (P.36)** has to set to 10 bit or 12 bit.

Analog input video:

Setting in **8.3.4 [F64] Color bit for analog video input (P.32)** has to set to 10 bit or 12 bit.

【See: 8.4.4 [F20] Setting Deep Color (P.36)】

【See: 8.3.4 [F64] Color bit for analog video input (P.32)】

8.7 Other settings

8.7.1 [F90] Displaying firmware version

You can display the firmware version.

8.7.2 [F99] Setting maintenance/status display menu

You can set the display setting of the maintenance menu and status display menu.

Set value

- oFF : [Default]
- on : At the next start-up, settings of "oFF" will be applied.
- ALL : Always displays

[Table 8.10] Displaying menu

Setting	Menu		
	Setting value	Maintenance	Status display
oFF	Displayed	Not displayed	Not displayed
on	*	*	*
ALL	Displayed	Displayed	Displayed

* At the time of the next start-up, settings of "oFF" will be applied.

8.8 Checking operation (Maintenance menu)

You can set necessary items for operation verification.

This menu is enabled and displayed by setting [F99] to "on" or "ALL".

To finish the operation, set the "SET" key.

【See: 8.7.2 [F99] Setting maintenance/status display menu (P.54) 】

8.8.1 [C01] Setting sink device EDID check

You can set which signal mode will be chose if the HDC cannot read EDID from sink device.

Set value

oFF : recognize as DVI sink device when EDID read error is happened [Default]

Err : recognize as HDMI sink device when EDID read error is happened

ALL : recgnize HDMI sink device always

8.8.2 [C06] Setting HDCP input

Some source devices check whether the connected device supports HDCP and then those source devices decide whether they encrypt HDCP signals or not.

Since the HDC is HDCP compliant, if it is connected to a display device that does not support HDCP, video may not be displayed. In these cases, the problem can be solved by setting this menu to "oFF".

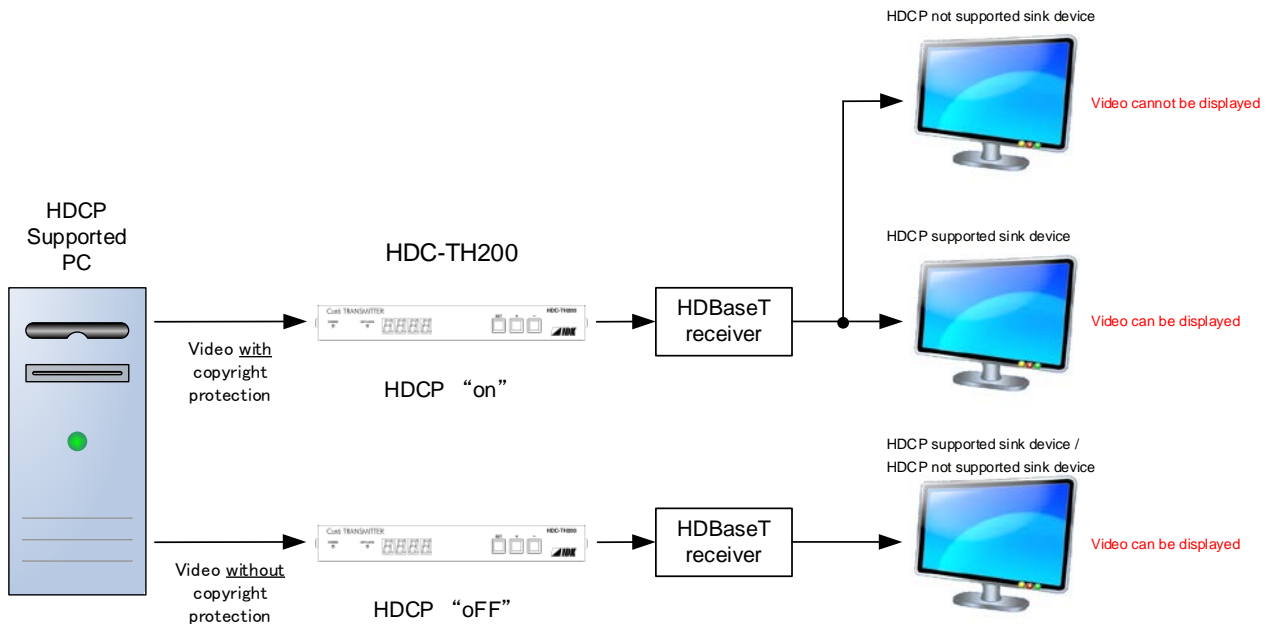

[Fig. 8.9] HDCP-supported and HDCP-non-supported display devices

Set value

- on : Enable HDCP encryption [Default]
- oFF : Disable HDCP encryption

【NOTE】 If you want to display which has HDCP, please use the HDC setting with "on".

8.8.3 [C10] Setting how long hot plug is ignored

You can set the masking time to ignore video output requests that are sent from the sink device. If those signals are repeatedly sent from the sink device within a short cycle, the HDC tries to set the video output every time. As a result, video may not be output. In this case, video can be output correctly by setting this menu.

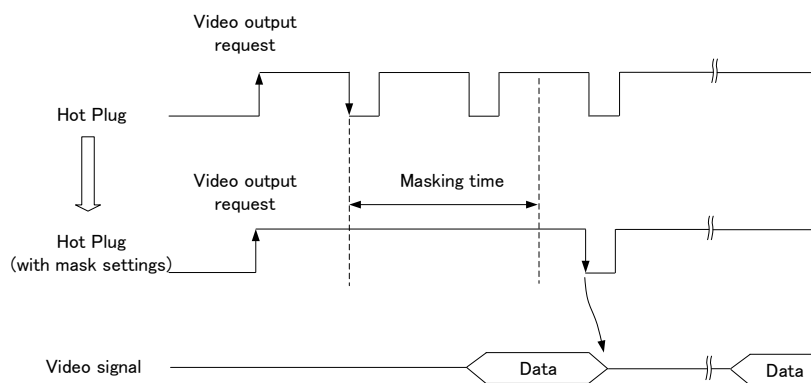
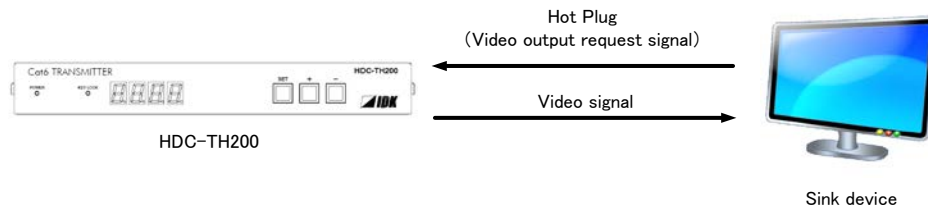

[Fig. 8.10] Hot plug ignorance time

Set value

oFF : no masking [Default]
02 to 15 : 2 to 15 seconds

8.8.4 [C30] Masking time after automatic switching of input channel

You can set masking time after automatic switching is executed.

This menu is available when set value in 8.2.1 [F05] Priority of input channel automatic switching (P.28) is set to "00 to 02".

Set value

oFF : no masking
0.5 to 10 : 0.5 to 10 seconds (0.5 sec step) [Default: 1 seconds]

8.8.5 [C55] Setting forced output color mode

You can set output color space which is output to the sink device.

Set value

- oFF : Auto [Default]
- rgb : RGB output
- 422 : YCbCr422 output
- 444 : YCbCr444 output
- d : DVI output

8.9 Displaying input/output statuses (Status display menu)

Input and output statuses of the HDC can be displayed.

The status display menus can be operated by setting [F99] to "on" (Display) or "ALL" (Always display).

Press the "SET" key to exit the operation.

【See: 8.7.2 [F99] Setting maintenance/status display menu (P.54) 】

8.9.1 [L00] Display selected input channel

[Table 8.11] Selected input channel information

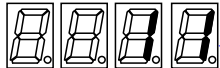
Menu number	Displayed value	Description
● Selected input channel information		
L00	 <p>1 : Digital video 2 : Analog video — : No input</p>	<p>1 : Digital audio 2 : Analog audio — : no digital audio or audio cannot be output</p>

8.9.2 [L01 to L13] Displaying digital input information

[Table 8.12] Digital input information

Menu number	Displayed value	Description
● HDMI / DVI mode and color depth of input video		
L01	H08	HDMI 24 bit / pixel (8bit / component)
	H10	HDMI 30 bit / pixel (10bit / component)
	H12	HDMI 36 bit / pixel (12bit / component)
	d08	DVI 24 bit / pixel (8bit / component)
	---	No input
● HDCP of input video		
L02	on	with HDCP
	oFF	without HDCP
	---	No input
● Color space of input video		
L04	rgb	RGB
	422	YCbCr 422
	444	YCbCr 444
	---	Unknown or no input
● Input video frequency		
L05	59.9	Input vertical synchronization frequency (with 59.9 Hz)
	---	No input
● DDC power supply		
L06	on	DDC powered on
	oFF	DDC powered off
● Input resolution		
L07	1920_1080P 60	Scroll display of input resolution (For 1920x1080p 60 Hz)
	---	No input

[Table 8.13] Digital input information

Menu number	Displayed value	Description
The segment display is three digits. The first (left) two digits show the audio format, and third digit (X) shows the number of audio channels (1 = 2 channels, 2 = 2.1 channels, 5 = 5.1 channels, 7 = 7.1 channels).		
L10	- - -	Unknown or no input
	00n	Unknown
	01n	PCM Audio
	02n	AC-3 Audio
	03n	MPEG-1 Audio
	04n	MP3 Audio
	05n	MPEG-2 Audio
	06n	AACLC Audio
	07n	DTS Audio
	08n	ATRAC Audio
	09n	DSD Audio
	10n	Dolby Digital Plus Audio
	11n	DTS-HD Audio
	12n	Dolby TrueHD Audio
	13n	DST Audio
14n	WMA Audio	
15n	HE-AAC / HE-AACv2 / MPEG Surround Audio	
● Audio input sampling frequency		
L11	22	22.05 kHz
	24	24 kHz
	32	32 kHz
	44	44.1 kHz
	48	48 kHz
	88	88.2 kHz
	96	96 kHz
	176	176.4 kHz
	192	192 kHz
	768	768 kHz
	_01	Unknown
	_05	
	_07	
	_11	
	_13	
_15		
- - -	No input	
● Audio input bits, HBR (High Bit-Rate Audio)		
L12	H16	16 bit, HBR mode
	P16	16 bit, PCM mode
	:	:
	H24	24 bit, HBR mode
	P24	24 bit, PCM mode

	---	No input
● Audio input status (Digital audio)		
L13	000	No audio input
	001	Being input detecting
	002	
	003	
	004	
	005	
	006	
	007	Normal input
	---	No input

8.9.3 [L20 to L22] Displaying analog input information

[Table 8.14] Analog input information

Menu number	Displayed value	Description
● Analog input signal type		
L20	00	Analog RGB
	01	Analog YPbPr
	02	Composite video
	03	S-video
	---	No input
● Analog input vide frequency		
L21	59.9	Input vertical synchronization frequency (with 59.9 Hz)
	---	No input
● Analog input resolution		
L22	1920_1080P 60	Scroll display of input resolution (For 1920x1080p 60 Hz)
	---	No input

8.9.4 [L30 to L60] Output information

[Table 8.15] Output information

Menu number	Displayed value	Description
● Deep Color: sink device status		
L30	08	24 bit / pixel (8 bit / component) supported
	10	30 bit / pixel (10 bit / component) supported
	12	36 bit / pixel (12 bit / component) supported
	- - -	Not connected
● HDMI / DVI sink device status		
L35	HC	HDMI (Compressed audio supported)
	HP	HDMI (PCM audio supported)
	d	DVI (Audio not supported)
	- - -	Not connected
● Color space: output status		
L40	rgb	RGB supported
	422	RGB, YCbCr 422 supported
	444	RGB, YCbCr 444 / 422 supported
	- - -	Not connected
● HDCP authorization		
L45	000	None
	001	Being authorized
	002	
	003	
	004	Authorization ended normally
	005	Authorization ended abnormally
● Output color space		
L50	rgb	RGB output
	422	YCbCr 422 output
	444	YCbCr 444 output
	- - -	Not connected
● HDCP status		
L55	on	HDCP supported
	oFF	HDCP not supported or no HDCP signal
	Err	Sink device info. read error
	- - -	Not connected
● Hot plug detection status		
L60	on	With Hot plug detection
	oFF	Without Hot plug detection

9 Product specification

9.1 Specification

Item			Description	
Input	Video	HDMI / DVI	Number / Signal	1 input / HDMI Deep Color (*1), DVI1.0 - HDCP 1.4 (Pass through) (*2) - CEC (Pass through) - TMDS clock: 25 MHz to 225 MHz - Dot clock: 25 MHz to 165 MHz
			Connector	1 female HDMI Type A
			Others	Built-in cable EQ, EDID emulation
		Universal analog	Number / Signal	1 input / Composite video, S-Video, Analog RGB/Analog YPbPr (auto-recognition) - Composite video (VBS Signal): 1.0 V[p-p]/75 Ω - Y/C Signal: 1.0 V [p-p] (Y) /0.286 V [p-p] (C) /75 Ω - Analog RGB: 0.7 V [p-p] / 75 Ω HS/VS TTL level, - Analog YPbPr: 1.0 V [p-p] (Y) /0.7 V [p-p] (Pb/Pr) /75 Ω
			Connector	1 female 15-pin HD
			Others	EDID emulation
	Formats		NTSC / PAL 480i / 480p / 576i / 576p / 720p / 1080i / 1080p VGA to QWXGA * WUXGA / QWXGA: only Reduced Blanking is supported.	
	Audio	Digital	Number / Signal	1 input / Multi-channel linear PCM up to 8 channels - Sampling frequency: 32 kHz to 192 kHz - Sample bit: 16 bit to 24 bit - Reference level:-20 dBFS - Max. input level: 0 dBFS
			Connector	1 female HDMI Type A
		Analog	Number / Signal	1 input / Stereo L/R unbalanced signal - Input impedance: 24 kΩ - Reference level: -10 dBu - Max. input level: +10 dBu
Connector			1 Stereo mini pin jack 3.5 mm	
Output	Video	Number / Signal	1 output / HDBaseT Cable: Cat5e/Cat6 (STP/UTP straight cable), CAT.5E HDC cable (*4)	
		Connector	1 RJ-45 (*3)	
	Audio	Number / Signal	1 output / Multi-channel linear PCM up to 8 channels - Sampling frequency: 32 kHz to 192 kHz - Sample size: 16 bit to 24 bit - Reference level: -20 dBFS - Max. output level: 0 dBFS	
		Connector	1 RJ-45	
Max. extension distance	Input	HDMI/DVI	From 32.8 ft. / 10 m up to 99 ft. / 30 m (approx.) (*5)	
	Output	HDBaseT	Max. 330 ft. / 100 m (approx.) (*6)	

Function	Analog video processing		3D Y/C separation
	Others		Auto input detection and switching Last memory Anti-Snow (*7) Connection Reset (*8) Front panel security lockout
Control port	LAN	Number / Signal	1 port / 10Base-T (Auto Negotiation), 100Base-TX (Auto Negotiation), Auto MDI/MDI-X
		Connector	1 RJ-45
Others	AC adapter		Input: 100 - 240 VAC \pm 10%, 50 Hz / 60 Hz \pm 3 Hz Output: 12 VDC 3 A 36 Watts (AC adapter is supplied)
	Power consumption		About 11 Watts
	Dimensions		8.27 x 1.08 x 5.91"/ 210 (W) x 27.5 (H) x 150 (D) mm (EIA rack 1/2U widths and low height, not including projections)
	Weight		1.98 lbs. / 0.9 kg
	Temperature		Operating: 32°F to 104°F / 0°C to +40°C Storage: -4°F to +176°F / -20°C to +80°C
	Humidity		Operating/ Storage humidity: 20% to 90% (Non Condensing)

- *1 30 bit/pixel (10 bit/component) and 36 bit / pixel (12 bit / component) Deep Color is supported while xvYCC, 3D, ARC and HEC are not supported.
- *2 HDCP-compliant DVI signals are not supported. To transmit these signals, use our extender which supports DVI signals or MSD-402.
- *3 RJ-45 (HDBaseT output connector) is only for Cat5e/Cat6 twisted pair cable. Please do not use it for LAN devices or the like.
- *4 T568A or T568B straight connection. HDC.CAT5E cable is HDBaseT recommended cable which IDK developed.
- *5 The extension distance depends on connected I/O devices. The distance above is the maximum transmission distance when a cable made by IDK (AWG24) is used and signals, 1080p@60 24 bit / pixel (8 bit / component), are input or output. If the connected device is not matched to the unit or if other makers' cables are used, video signals can be unstable or video signals cannot be output, even though the transmission distance is within the distance above.
- *6 If connected to a device whose status is significantly bad, video signal can be unstable or cannot be output. Check the operation beforehand or contact us.
- *7 The anti-snow feature automatically fixes snow noise that is a specific symptom of HDCP-compliant signals and mainly occurs at start-up. This feature does not work when snow noise has already occurred during startup or when it occurs due to a bad condition of the transmission line.
- *8 For digital systems, some problems, such as an HDCP authentication error, can often be recovered by physically disconnecting and reconnecting the digital cables. However, the Connection Reset feature will fix these problems automatically without the need to physically plug and unplug the cables. It creates the same condition as if the cable were physically disconnected and reconnected. This feature only works for the HDC's output. If other devices are connected between the HDC's output and sink device, this feature may be invalid.

10 Troubleshooting

This chapter recommends what to do if you have problems operating the HDC.

In case the HDC does not work correctly, please check the following items first.

- Are the HDC and all devices plugged in and powered on normally?
- Are cables connected correctly?
- Are there no loose connections?
- Are correct cables supported by devices being used?
- Are signal specifications of connected devices matched to each other?
- Are settings of the sink device correct?
- Are there any close objects that may cause noise?

If the problem still cannot be solved, perform the following actions. Refer to manuals of connected devices as well, since they may possibly be the cause of the problem.

Problem	Cause/Check item/Solution	Page
● Video output		
Digital video input is not output.	[1] When digital input video is not output, check the source device status. See 8.9.2 [L01 to L13] Displaying digital input information (P.60) <ul style="list-style-type: none"> · [L06] DDC power status is “oFF” (no DDC power input) Please check if the source device is turned on. · [L07] Input resolution is “- - -” (no input) Please check the output status of the source device · If you can see resolution and frequency of the input signal, please confirm that those resolution and frequency are supported by connected sink device. 	60
	[2] Please check if the input signal has HDCP or not. <ul style="list-style-type: none"> · [L02] HDCP status is “on” (HDCP), please check the connected sink device supports HDCP or not. Please check [L55] HDCP status: sink device Some source devices output HDCP signal always depending on connected device. The HDC supports HDCP. If you connect the sink device which does not support HDCP, you cannot get video image. In this case, please see 8.8.2 [C06] Setting HDCP input (P.56) and disable HDCP input. 	60 63 56
	[3] Please try to change 8.3.1 [F16] No-signal input monitoring (P.31) If the setting is less than output timing from source device, you may not be able to get video image. In this case, please set the value to longer time.。	31
	[4] Please try to change 8.3.2 [F17] Digital input equalizer (P.31) .	31

Problem	Cause/Check item/Solution	Page
● Video output		
Analog input video is not output	<p>[5] When analog input video is not output, please check input signal status. See 8.9.3 [L20 to L22] Displaying analog input information (P.62).</p> <ul style="list-style-type: none"> ▪ [L20] Analog input signal type is “- - -” (no input) Please check connection between the unit and source. ▪ [L22] Analog input resolution is “- - -” (no input) Please check output status of source device. ▪ If you can see resolution and frequency of the input signal, please confirm that those resolution and frequency are supported by connected sink device. 	62
	<p>[6] Please try to change 8.3.3 [F07] Analog input signal type (P.32).</p> <p>Normally, if you set to “Auto”, the input signal is automatically recognized. However, depending on the signal condition, the HDC may not be able to recognize input signal. In this case please set signal type manually.</p>	32
Video is not output	<p>[7] Please check a sink device status. See 8.9.4 [L30 to L60] Output information (P.63).</p> <ul style="list-style-type: none"> ▪ [L60] Hot plug detection is “oFF” (no hot plug) Please check sink device if the unit is turned on. 	63
	<p>[8] Is resolution set to the supported resolution in 8.4.2 [F10 to F11] Setting EDID resolution (P.34).</p> <ul style="list-style-type: none"> ▪ Factory default setting is 1080p. ▪ If you set EDID resolution to 1080i, there is possibility that the sink device does not support interlace signal. ▪ Monitor for PC may not support resolutions for TV. On the other hand, TV may not support resolutions for PC (VGA to QWXGA). 	34
	<p>[9] Please try to change 8.8.3 [C10] Setting how long hot plug is ignored (P.57).</p>	57

Problem	Cause/Check item/Solution	Page
● Video output		
Video is disappeared, interrupted, or has noise.	If using a long cable for input or output, replace it with a 5 m/16.4 ft. or shorter cable. Since the MSD has the equalizing function, long cables can be connected, but the MSD may not provide its full performance depending on the cable quality and the connected device. If the problem is solved by replacing the cable, signal might have been degraded due to the long haul transmission. We have high-quality cables, cable boosters and extenders. Please contact us as needed. In case of HDBaseT input, twisted pair cable might be having external noise. Please check twisted pair cable.	—
	When high-speed signal (high resolution: such as UXGA, WUXGA, 1080p; DEEP COLOR signal) are input or output, video may not be displayed or noise may appear depending on the cable quality and the connected device. For digital video input, you can limit color depth in 8.4.4 [F20] Setting Deep Color (P.36) . For analog video input, you can limit color depth in 8.3.4 [F64] Color bit for analog video input (P.32) . For Video output, you can limit color depth in 8.6.2 [F70] Setting Deep Color output (P.53) .	36 32 53
	Video image may be interrupted by external noise from peripheral equipment. In this case, please put away the unit which may output noise from the HDC, or turn off/on the HDC without video image. If the problem still cannot be solved, shorten the length of the twisted pair cable.	18
Video is interrupted, or has noise.	If the symptom happens only on digital video input, please check setting of equalizer.	31
Video is interrupted.	If interlace signal is input to a sink device that does not support interlace signal, the video may blink. Check the output resolution of the sink device.	—
Video from analog input is displayed in black-and-white or green.	Please try to change 8.3.3 [F07] Analog input signal type (P.32) .	32
VHS reproduction or fast-forward is choppy when analog composite video or analog S-Video is input.	Please set to "Auto video", "Composite" or "S-Video" in 8.3.3 [F07] Analog input signal type (P.32) .	32

Problem	Cause/Check item/Solution	Page
● Video output		
Part of video is cut off or black is displayed at edge(s).	For analog input, set the automatic measurement of input timing in 8.5.1 [F08] Automatic measurement (P.42) . If there is problem still, please set by manually, using menu [F42] to [F52] .	42 46 to 52
Analog input video signal aspect is not correct.	There may be unknown input signal is input. The HDC cannot recognize the input signal correctly. In this case please execute automatic measurement by specifying aspect ratio.	42
Black appears at top, bottom, right and left on PC video or only part of the PC video is displayed, and the rest is displayed by scrolling with the mouse.	Does the resolution setting for the PC (You can check it in "Properties" of the PC) and the resolution output from the PC match? If not, set the EDID and PC resolution. You can confirm output signal from PC in [L07] Input resolution . If the signal is analog; you can confirm the resolution in [L22] Analog input resolution . If the copy of the built-in LCD monitor in the laptop is output, the resolution of the LCD monitor is applied for outputting the video to the external monitor, and black bars may appear at edges. The problem can be solved by enlarging the display or displaying only to the external monitor.	60 62 34
PC's dual monitor cannot be set or the setting is canceled.	If the monitoring function for no-signal input works, the dual monitor function may not operate correctly. In this case, turn the monitoring function "OFF" in 8.3.1 [F16] No-signal input monitoring (P.31) .	31
Video from a PC of analog input is displayed with bright-and- dark vertical stripes	Set 8.5.3 [F42] Setting the total number of horizontal dots (P.46) If you change the total number of horizontal dots, you may sometimes have to set [F43] to [F52] menus also.	46
Light shadows appear on fine lines of video from an analog input PC.	Please try to change 8.5.14 [F53] Tracking (P.52) .	52
Fluctuation appears on the analog input video.	Please try to change 8.5.14 [F53] Tracking (P.52) .	52
Automatic measurement of input timing fails.	In order to enable this menu, the input video must have 25% or more brightness and its edges (all sides) need to be in contact with the circumscribed rectangle in the effective display area.	42
Display position of analog input video changes on its own.	If the function that automatically adjusts the display position (upper left of the screen) works by automatic measurement, the video may move on its own. In this case, disable the adjusting position function.	44
● Audio output		
Audio is not output.	Please confirm the setting in 8.6.1 [F65] Setting audio output (P.53) is "on".	53

Problem	Cause/Check item/Solution	Page
● Audio output		
Audio from digital input is not output.	Is the video image output normally? If there is no video please confirm [1],[2],[3],[4],[7],[8], and [9]	—
	Is DVI signal output from the source device? You can check the input signal type in [L01] HDMI / DVI mode and color depth of input video . Also there is the case DVI signals is output by EDID setting.	60 34
	Is audio format being used supported by the connected sink device or AV amplifier input? LCD monitors, especially, may not output 88.2 kHz or more sampling frequency of linear PCM and compressed audio (such as Dolby Digital, DTS, and so on). Audio signal output from the source device can be controlled by setting EDID.	61 34
	Make sure that the resolution that can be output from the sink device or AV amplifier is selected. If a PC output resolution (VGA to QWXGA) is selected, some sink devices and AV amplifiers cannot output audio.	60
	Make sure that the sampling frequency is supported by the sink device or AV amplifier. Some LCD monitors may not output audio whose sampling frequency is high (88.2 kHz or higher).	61
Compressed audio (such as Dolby Digital, DTS) is not output from the source device.	Compressed audio input is controlled (EDID settings) by factory default. If using compressed audio, change the EDID setting	37 to 39
	In order to output compressed audio of multi-channel, set the number of speakers.	40
	Check the audio output settings of the source device.	—
Multi-channel audio is not output.	In order to output multi-channel audio, set the number of speakers.	40
● Key operation		
Keys do not operate	Make sure that keys are not locked.	23
● Ohters		
Devices cannot be controlled through CEC.	Are HDMI cables supporting CEC being used?	—
	To use CEC, enable HDMI link control of the connected devices (such as LCD TVs, Blu-ray recorder, and so on).	—

If additional assistance is required, please perform the following tests and then contact us.

1. The problem occurs at all connectors?
2. Connect the devices using genuine cables without connecting the HDC.

The problem still cannot be solved? Please contact us for assistance.

User's Guide of HDC-TH200

Ver.1.1.0

Issued on: 11 April 2017



Headquarters

IDK Corporation
7-9-1 Chuo, Yamato-shi, Kanagawa-pref.
242-0021 JAPAN
TEL: +81-46-200-0764 FAX: +81-46-200-0765

Email: idx_eng@idx.co.jp URL: <http://www.idx.co.jp/en/index.html>

USA

IDK America Inc.
72 Grays Bridge Road Suite 1-C, Brookfield, CT 06804
TEL: +1-203-204-2445

Email: sales@idxav.com URL: <http://www.idxav.com>

Europe

IDK Europe GmbH
Lise-Meitner-Str. 6, D-40878 Ratingen
TEL: +49-2102-578-301-0

Email: info@idxav.eu URL: <http://www.idxav.eu>



Product information Support

Arvanics Corporation
7-9-1 Chuo, Yamato-shi, Kanagawa-pref.
242-0021 JAPAN
TEL: +81-46-259-6920 FAX: +81-46-259-6930

Email: info@arvanics.com URL: <http://www.arvanics.com>

Information in this document is subject to change without notice.
All rights reserved. All trademarks mentioned are the property of their respective owners.